

Multia MultiClient Desktop

Service Information

Part Number: EK-MULTS-IN. C01

October 1995

This guide describes how to troubleshoot and service the Multia MultiClient Desktop. The guide covers Alpha- and Intel-based models.

- System overview
- Troubleshooting
- Console commands (Alpha-based models)
- BIOS Setup utility (Intel-based models)
- Removing and replacing FRUs
- Restoring Multia desktops to an initial software state
- Part numbers and pinouts

Revision/Update Information: This is a revised document.

First Edition, January 1995

Third Edition, October 1995

Digital Equipment Corporation makes no representations that the use of its products in the manner described in this publication will not infringe on existing or future patent rights, nor do the descriptions contained in this publication imply the granting of licenses to make, use, or sell equipment or software in accordance with the description.

Possession, use, or copying of the software described in this publication is authorized only pursuant to a valid written license from Digital or an authorized sublicensor.

© Digital Equipment Corporation 1995. All rights reserved.

The postpaid Reader's Comments form at the end of this document requests your critical evaluation to assist in preparing future documentation.

The following are trademarks of Digital Equipment Corporation: Alpha, Digital, DECnet, LAT, Multia, the Multia logo, OpenVMS, PATHWORKS, ThinWire, and the DIGITAL logo.

The following are third-party trademarks:

Intel and Pentium are registered trademarks of Intel Corporation.

Microsoft, MS-DOS, and Windows 95 are registered trademarks, and Windows and Windows NT are trademarks of Microsoft Corporation.

NetBIOS is a trademark of Micro Computer Systems, Inc.

OSF is a trademark of the Open Software Foundation.

PS/2 is a registered trademark of International Business Machines Corporation.

RUMBA is a registered trademark of Wall Data, Inc.

TrueType is a registered trademark of Apple Computer, Inc.

UNIX is a registered trademark in the United States and other countries, licensed exclusively through X/Open Company Ltd.

All other trademarks and registered trademarks are the property of their respective holders.

Contents

About This Guide

1 Multia System Description

Overview	1
System Hardware Features	1
Software Features.....	3
Front View	4
Rear View	4
Specifications	5
System Board.....	5
Memory	5
Power Supply.....	5
Mechanical	5
Environment	6
Configuration.....	6
System Box.....	6
Memory	7
Options	8

2 Troubleshooting Alpha-Based Models

Troubleshooting Overview.....	9
Troubleshooting Equipment.....	10
Troubleshooting	10
Power System Problems	10
Initialization and Power-On Self-Test Errors.....	10
SRAM LED Codes.....	11
Console Troubleshooting	12
Machine Checks	12
Battery Problems.....	13
Boot Problems	13
Network Problems.....	14
Memory Problems.....	15
Floppy Drive Problems	15
SCSI Drive Problems	16
Thermal Problems.....	17
PCI Bus Error Detection	17
Accessing the Windows NT Event Logs	17

3 Troubleshooting Intel-Based Models

Troubleshooting Overview	18
Initial Troubleshooting.....	18
Computer Troubleshooting.....	18
No response when the computer is turned on.....	19
Power is on, but there is no screen display.	19
Computer operates incorrectly after installation of optional expansion board.	19
Computer operates incorrectly after installation of optional system memory (SIMMs).	19
Computer fails to retain setup information.	20
Computer does not boot from an IDE hard disk drive.	20
Computer does not recognize an external SCSI device.	20
Computer does not boot from a target diskette drive.	21
No response to keyboard commands.....	21
No response to mouse commands.....	21
Disk Drive Troubleshooting	21
IDE/SCSI hard disk drive cannot read or write information.	22
Target diskette drive cannot read or write information.	22
Monitor Troubleshooting	22
Monitor power indicator is not on.	22
No screen display.	23
No monitor display while loading Windows video drivers.....	23
Distorted, rolling, or flickering screen display, or wrong/uneven color.	23
Monitor fails to switch to high-resolution mode.	23
Monitor display not centered while loading Windows video drivers.	24
Network Interface Troubleshooting.....	24
Power is on, LAN address is installed on server; system hangs.....	24
Network does not start.....	24
Audio Troubleshooting	24
SCSI Device Troubleshooting.....	24
Cannot access the CD-ROM drive. Error message reading drive <i>x</i>	25
Power is on, but the indicator shows no activity.	25
Disc is spinning but drive is idle.....	25
POST and Boot Messages	25
POST and Boot Error Messages	25
POST and Boot Informational Messages	27
Beep Codes.....	27
Accessing the Windows NT Event Logs	28

4 Console Commands (Alpha-Based Models)

ARC Console Commands	29
Supplementary Menu	30
Set Up Menu	31
Boot Selection Menu.....	33
SRM Console Commands	34
SRM Console Conventions.....	34
SRM Console Special Characters	35
Specifying SRM Devices in Commands	35
Deposit Command.....	36
Examine Command.....	37
HD (Hexadecimal Dump).....	38
Show Command.....	39
Setting the Default Console.....	40

Resetting the Boot Configuration.....	41
---------------------------------------	----

5 BIOS Setup Utility (Intel-Based Models)

Running the BIOS Setup Utility.....	44
Navigating in the BIOS Setup Utility.....	44
Shortcut Keys.....	45
Item-Specific Help.....	45
Navigating Between Menus.....	45
Exit Menu Options.....	45
BIOS Setup Utility Options.....	45
Main Menu Options.....	46
IDE Hard Disk Options.....	46
Memory Cache Options.....	47
Memory Shadow Options.....	48
Boot Options.....	48
Keyboard Options.....	48
Advanced Options.....	49
Integrated Peripherals.....	49
Advanced Chipset Control.....	50
Security Options.....	51
Power Options.....	52
Resetting the Boot Configuration.....	53

6 Removing and Replacing FRUs

Before You Start.....	54
Accessing the Component Drawer.....	55
Memory Modules (SIMMs).....	55
Cache Memory.....	56
Alpha Processor Upgrade.....	57
Intel Processor Upgrade.....	59
PCI Option.....	61
Power Supply.....	62
Floppy Disk Drive.....	65
2.5-Inch Hard Disk Drive.....	66
3.5-Inch Hard Disk Drive (Alpha-Based Models).....	68
3.5-Inch Disk Drive (Intel-Based Models).....	69
Backplane.....	70
System Board.....	71
Battery.....	73
Speaker.....	74
Floppy Disk Drive Cable.....	75

7 Restoring Multia Software

Restoring Multia Software on a Corrupted Desktop.....	77
Restoring Intel-Based Models (Multia Version 3.1).....	77
Restoring Alpha-Based Models (Multia Version 3.0).....	79
Setting Up Servers for the Remote Maintenance Facility.....	80
Configuring a Multia MOP Server.....	81
Configuring an OpenVMS MOP Server.....	81
Starting the Multia MOP Server.....	81
Configuring a BOOTP Server.....	82

Starting the Multia BOOTP Server.....	83
Specifying a Multia MOP or TFTP Startup Account	83

A Part Numbers

Recommended Spares List	85
Field Replaceable Units	85
General Recommended Spares	86
Hardware	87
Part Numbering Conventions	87
Multia Single System Box.....	88
Memory Modules	91
Disk Drives	91
Keyboards	92
Digital Color Monitors.....	92
Cables.....	93
Related Documentation.....	94

B Pinouts

Bidirectional Parallel Port Pinouts	95
Communications Port Pinouts	96
External SCSI Port Pinouts	97
Floppy Disk Controller Pinouts	98
Keyboard Port Pinouts	98
Mouse Port Pinouts	99
Network Ports Pinouts.....	99
Thickwire Pinouts (J2)	99
ThinWire Pinouts (J3)	100
Twisted Pair (J4) Pinouts.....	100
Power Port (J10) Pinouts	101
Video Port (J1) Pinouts	101
System Board Jumpers (Alpha-Based Models).....	102
System Board Jumpers (Intel-Based Models)	103

Index

About This Guide

Audience

This guide is for Digital service personnel and qualified self-maintenance customers.

Purpose

This guide describes how to troubleshoot and service the Multia MultiClient Desktop. The guide covers Alpha- and Intel-based models:

- System overview
- Troubleshooting Alpha-based models
- Troubleshooting Intel-based models
- Console commands (Alpha-based models)
- BIOS Setup utility (Intel-based models)
- Removing and replacing FRUs
- Restoring Multia desktops to an initial software state
- Part numbers and pinouts

Multia System Description

Overview

The Multia MultiClient Desktop is a network-ready device that implements the application server method of client-server computing. The desktop comes with the Windows NT Workstation operating system and Multia Base Software preinstalled. Alpha- and Intel-based models are available.

The desktop provides users with access to Windows, Windows NT, and video terminal applications on host systems and file servers in a variety of network environments. As options, users can add access to X window applications and mainframe applications.

The Multia Base Software includes a Configuration Manager that lets a system administrator centrally manage and configure Multia MultiClient Desktops across a local area network (LAN) or wide area network (WAN). The CD-ROM in the System Administrator Kit provides a copy of the base software plus options and Remote Maintenance Facility (RMF) software for restoring desktops to their initial software state. Administrators can use the CD-ROM to upgrade and repair desktops.

System Hardware Features

Alpha-Based Models

The VX40 model has a fixed 166 MHz Alpha CPU and fixed 256K cache memory.

The VX41 model has an upgradable 166 MHz Alpha CPU and upgradable 256K cache memory.

The VX42 model has an upgradable 233 MHz Alpha CPU and upgradable 512K cache memory.

- 166 MHz or 233 MHz Alpha CPU
- ZIF socket for CPU upgrades (VX41 and VX42 models)
- High-performance PCI-based graphics accelerator
- 24 MB memory, expandable to 128 MB
- ECC memory that supports error detection and correction
- 528 MB or 540 MB hard disk drive (2.5 inch or 3.5 inch)
- Floppy disk drive (standard on VX41 and VX42 models, optional on the VX40 model)
- 256 KB, 512 KB, and 1MB cache memory options

Overview

- Two PCMCIA slots (type 1 or 2)
- Autosensing PCI-based Ethernet connections: thickwire (10Base5), ThinWire (10Base2), twisted pair (10BaseT)
- CD-quality input/output, optional headset and microphone, and built-in speaker
- Multisynchronous monitor support for 640x480, 1024x768, and 1280x1024 screen resolutions at 60 Hz to 75 Hz refresh rate, VGA
- Two serial lines, both with full modem support
- Bidirectional parallel port
- Keyboard options
 - LK411 (108 keys, Digital layout)
 - PCXAL (101/102 keys, PC layout)
- 3-button mouse
- PCI option slot, short card format (on systems with a 2.5-inch hard disk drive)
- SCSI-2 connector (standard on the VX41 and VX42 models, optional on the VX40 model)
- Kensington lock-ready
- Regulatory compliance

Intel-Based Models

The VX51 model provides an upgradable 100 MHz Pentium CPU and upgradable 256K cache memory.

- 100 MHz Pentium CPU
- ZIF socket for CPU upgrades
- High-performance PCI-based graphics accelerator
- 16 MB memory, expandable to 128 MB
- 810 MB or 1.6 GB hard disk drive (2.5 inch or 3.5 inch)
- Floppy disk drive
- 256 KB and 512 KB asynchronous, synchronous, or synchronous burst cache memory options
- Two PCMCIA slots (type 1 or 2)
- Autosensing PCI-based Ethernet connections: thickwire (10Base5), ThinWire (10Base2), twisted pair (10BaseT)
- CD-quality input/output, optional headset and microphone, and built-in speaker
- Multisynchronous monitor support for 640x480, 1024x768, and 1280x1024 1600x 1200 screen resolutions at 60 Hz to 75 Hz refresh rate, VGA
- Two serial lines, both with full modem support
- Bidirectional parallel port
- Keyboard options
 - LK411 (108 keys, Digital layout)
 - PCXAL (101/102 keys, PC layout)

- 3-button mouse
- PCI option slot, short card format (on systems with a 2.5-inch hard disk drive)
- SCSI-2 connector
- Kensington lock-ready
- Regulatory compliance

Software Features

Multia MultiClient Desktop (Preinstalled Software)

The Multia MultiClient Desktop comes with preinstalled Multia Base Software and the Windows NT Workstation operating system.

- Alpha-based models use Multia Base Software Version 3.0 or earlier and the Windows NT Workstation Version 3.5 operating system
- Intel-based models use Multia Base Software Version 3.1 and the Windows NT Workstation Version 3.51 operating system

All models include

- User-selectable setup in English, French, German, and Spanish
- Application Manager
- Configuration Manager
- Status application
- Terminal emulator
- World Wide Web browser
- Reference Desk, online help, and tutorial
- TrueType PC font support
- Communications protocols
 - IPX/SPX
 - LAN Manager
 - NetBEUI
 - NetBIOS
 - PATHWORKS
 - TCP/IP
 - DECnet (Multia Version 3.0 and later)
 - LAT
 - NFT (bundled with Multia X Server option)

Multia System Administrator Kit

The System Administrator Kit provides the Multia for System Administrators CD-ROM for performing software upgrades and repairs. The CD-ROM includes

- Multia Base Software
- Multia software options (Version 3.0 and later), including
 - Multia X Server
 - RUMBA for the Mainframe (3270 emulator)
- Remote Maintenance Facility (RMF) software for restoring Multia system disks

Overview

Front View

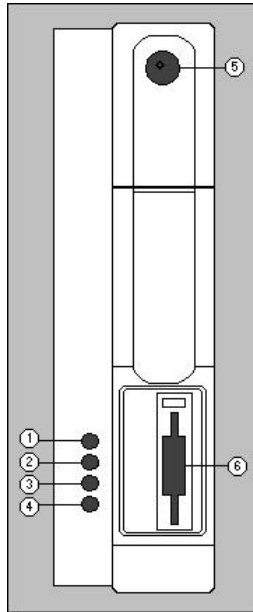

1. Stereo audio input
2. Stereo audio output
3. Microphone
4. Stereo headphones
5. On/off power switch
6. Floppy disk drive

Rear View

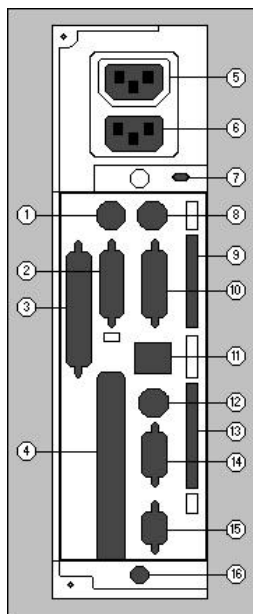

1. Keyboard connector
2. Serial port
3. SCSI-2 connector
4. PCI slot
5. Auxiliary power connector
6. AC input power connector
7. Kensington lock connector
8. Mouse connector
9. PCMCIA type 1 or 2 slot
10. Parallel port
11. Twisted pair Ethernet connector
12. ThinWire Ethernet connector
13. PCMCIA type 1 or 2 slot
14. Thickwire Ethernet connector
15. Video connector
16. Thumbscrews

Specifications

System Board

Alpha-Based Models

CPU model	Digital 21066-AA (LCA)	Digital 21068-AA (LCA)
Clock speed	166 MHz	233 MHz
Clock cycle	6.0 ns	4.3 ns

Intel-Based Models

CPU model	Pentium 100 MHz
Clock speed	66 MHz

Memory

Alpha-Based Models

Maximum memory	128 MB
Minimum memory	24 MB
Memory type	JEDEC Standard 36-bit SIMMs in 4 slots, 70 ns or faster
Cache memory (VX41 and VX42)	256 KB, 512 KB, and 1 MB options

Intel-Based Models

Maximum memory	128 MB
Minimum memory	16 MB
Memory type	JEDEC Standard 36-bit SIMMs in 4 slots, 70 ns or faster
Cache memory	256 KB asynchronous, 256 KB synchronous, 256 KB synchronous burst, and 512 KB options

Power Supply

Rated voltage range	100 V ac to 120 V ac 220 V ac to 240 V ac
Maximum voltage range	88 V ac to 264 V ac
Maximum input current	30 A to 40 A
Output power	74.5 W
Frequency range	47 Hz to 63 Hz

Mechanical

You can place the system box horizontally on a desktop or vertically in its stand.

Configuration

Horizontal dimensions	317.5 mm (wide) x 317.5 mm (deep) x 71 mm (high) 12.5 inches (wide) x 12.5 inches (deep) x 2.8 inches (high)
Vertical dimensions	127 mm (wide) x 317.5 mm (deep) x 342.9 mm (high) 5.0 inches (wide) x 12.5 inches (deep) x 13.5 inches (high)
Weight	5.45 kg (12 lb)

Environment

	Operating	Nonoperating
Temperature	0° C to 40° C 32° F to 104° F	-40° C to 66° C -40° F to 151° F
Relative humidity	10% to 90%	5% to 95%
Maximum wet bulb	28° C 82° F	46° C 115° F
Minimum dew point	2° C 36° F	— —
Maximum altitude	2.4 km 8000 ft	4.9 km 16,000 ft

Configuration

System Box

Alpha-Based Models

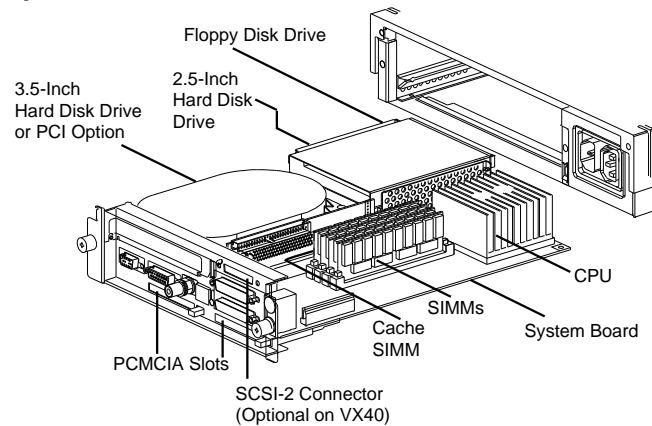

Intel-Based Models

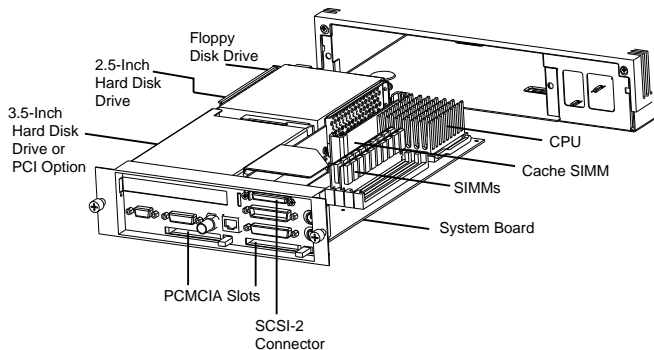

Memory

Alpha-Based Models

SIMMs are used in pairs. You can use 12 MB SIMMs only on models VX41 and VX42. To be recognized as 12 MB SIMMs, they must be in slots 0 and 1. If you use 12-MB SIMMs in slots 2 or 3, they are recognized as 8 MB SIMMs.

You can use 64 MB SIMMs if they meet the JEDEC standard and have a height of 1.5 inches. Currently, Digital's 64 MB SIMM does not fit in the system box.

Slot 0	Slot 1	Slot 2	Slot 3	Total
4 MB	4 MB	8 MB	8 MB	24 MB
12 MB	12 MB			24 MB
8 MB	8 MB	8 MB	8 MB	32MB
16 MB	16 MB			32 MB
4 MB	4 MB	16 MB	16 MB	40 MB
12 MB	12 MB	8 MB	8 MB	40 MB
8 MB	8 MB	16 MB	16 MB	48 MB
12 MB	12 MB	16 MB	16 MB	56 MB
16 MB	16 MB	16 MB	16 MB	64 MB
32 MB	32 MB			64 MB
4 MB	4 MB	32 MB	32 MB	72 MB
8 MB	8 MB	32 MB	32 MB	80 MB
12 MB	12 MB	32 MB	32 MB	88 MB
16 MB	16 MB	32 MB	32 MB	96 MB
32 MB	32 MB	32 MB	32 MB	128 MB
64 MB	64 MB			128 MB
4 MB	4 MB	64 MB	64 MB	136 MB
8 MB	8 MB	64 MB	64 MB	144 MB
12 MB	12 MB	64 MB	64 MB	152 MB
16 MB	16 MB	64 MB	64 MB	160 MB
32 MB	32 MB	64 MB	64 MB	192 MB
64 MB	64 MB	64 MB	64 MB	256 MB

Configuration

Intel-Based Models

You can use 64 MB SIMMs if they meet the JEDEC standard and have a height of 1.5 inches. Currently, Digital's 64 MB SIMM does not fit in the system box.

Slot 0	Slot 1	Slot 2	Slot 3	Total
4 MB	4 MB	8 MB	8 MB	24 MB
8 MB	8 MB	8 MB	8 MB	32 MB
16 MB	16 MB			32 MB
4 MB	4 MB	16 MB	16 MB	40 MB
8 MB	8 MB	16 MB	16 MB	48 MB
16 MB	16 MB	16 MB	16 MB	64 MB
32 MB	32 MB			64 MB
4 MB	4 MB	32 MB	32 MB	72 MB
8 MB	8 MB	32 MB	32 MB	80 MB
16 MB	16 MB	32 MB	32 MB	96 MB
32 MB	32 MB	32 MB	32 MB	128 MB
64 MB	64 MB			128 MB

Options

Multia System Box Part Number Suffix	Floppy Disk Drive	Hard Disk Drive	PCI	PCMCIA
N	Can be added	Can be added	Can be added	Can be added
F	Included	Can be added	Can be added	Can be added
F2	Included	2.5 inch included	Can be added	Can be added
F3	Included	3.5 inch included	Not available*	Can be added
* The PCI option is not available in this configuration, because a 3.5-inch hard disk drive occupies the space allocated for a PCI board.				

Troubleshooting Alpha-Based Models

Troubleshooting Overview

Gathering information is the first action to perform when troubleshooting. Use the site log to review the system's service history. Ask the user or customer contact the following questions:

- What first alerted the user to the problem?
- Were there any recent changes or upgrades to the operating system, firmware, or application software?
- What symptoms did the user notice? Ask about any unusual sounds or smells.
- Did the user make any initial troubleshooting efforts? What were the results?

After you collect initial information on the problem, use this table to locate the troubleshooting section that addresses your problem:

If you have this problem...	Go to...
The system box fails to power up.	Power System Troubleshooting (page 10)
The system box powers up, but nothing is displayed on the monitor.	Power System Troubleshooting (page 10)
The system box powers up, but fails to boot.	Console Troubleshooting (page 12)
The monitor displays a crash dump.	Machine Checks (page 12)
The system hangs while displaying the <code>Setting console to boot mode</code> message or hangs after replacing the battery.	Battery Problems (page 13)
The system boots and the blue screen appears, but fails to boot the hard drive.	Boot Problems (page 13)
You cannot access network applications.	The SRM console, and see the Network Problems section (page 14)
The system is slow or displays less memory than you know is installed.	The SRM console, and see the Memory Problems section (page 15)
The floppy diskette is inaccessible for reading or writing during normal operation (Windows NT operating system running).	The SRM console, and see the Floppy Drive Problems section (page 15)
Your system fails to boot and you cannot solve the boot problems.	The SRM console, and see the SCSI Drive Problems section (page 16)

Troubleshooting Equipment

Be sure to have the following equipment available when troubleshooting:

- TW, thin, AUI loopback connectors (for network problems)
- FAT-formatted floppy diskette

Troubleshooting

During a normal power-up sequence, the following occurs:

- The green LED on the power switch at the front of the system box is on.
- The diagnostic LED between the serial port and twisted-pair connector on the back of the system box displays a list of sequence codes (page 11).

To address power system problems, you can check the power switch, diagnostic LED, and power port pinouts. The Power Systems Problems table gives common symptoms of power problems and recommends actions.

Power System Problems

Symptom	Recommended Action
The power switch LED is off.	<ol style="list-style-type: none"> 1. Make sure the power switch on the front of the system box is pushed in. 2. Make sure the system is plugged in and the power source is operating. Check the ac cord. 3. If the switch still does not work, replace the power supply. (The switch is hardwired to the power supply.)
The diagnostic LED on the back of the system box is off.	<ol style="list-style-type: none"> 1. If the LED never goes on, check the power supply. 2. For VX40 models, if the LED goes on but does not sequence, replace the system board (page 71). <p>On VX41 and VX42 models, the SROM does not flash on powerup.</p>
The power switch LED is on, but the monitor display is blank.	<ol style="list-style-type: none"> 1. Make sure the power switch on the front of the system box is pushed in. 2. Make sure the video controller cable is properly connected. 3. Check the SROM LED codes (page 11). 4. Make sure power is present at the system board. See Power Port Pinouts (page 100) for more information.

Initialization and Power-On Self-Test Errors

The diagnostic LED on the back of the system box indicates the symptom of any problem that occurs during initialization or the power-on self-test (POST).

When you turn on the system, the SROM initializes the CPU, core logic, and memory. During power-on, the CPU loads the POST from the SROM. Typically, the POST reports errors that prevent the console from booting.

During power-on, if the system fails a test, the LED flashes to indicate that the test failed. On the VX40 model, the diagnostic LED also flashes at the beginning of each self-test.

See the SROM LED code table for a list of SROM codes, descriptions, and recommended actions.

SROM LED Codes

The diagnostic LED on the system box flashes at power-up. On the VX40 model, the LED also flashes once (briefly) for each sequence number displayed. If the SROM code completes testing without errors, the LED remains off. If an error occurs, the LED flashes a hexadecimal code from the following table:

Code	Description	Recommended Action
F	Failed while sizing memory.	For VX41 and VX42 models, first replace the cache SIMM (page 56). If this does not fix the problem, continue with the recommended action for VX40 models. For VX40 models, replace memory modules (SIMMs) (page 55) until no failure occurs. If replacing the SIMMs does not fix the problem, replace the system board (page 71).
E	Failed while configuring memory.	For VX41 and VX42 models, first replace the cache SIMM (page 56). If this does not fix the problem, continue with the recommended action for VX40 models. For VX40 models, replace memory modules (SIMMs) (page 55) until no failure occurs. If replacing the SIMMs does not fix the problem, replace the system board (page 71).
D	Testing for mapped out MCRs.	For VX41 and VX42 models, first replace the cache SIMM (page 56). If this does not fix the problem, continue with the recommended action for VX40 models. For VX40 models, replace memory modules (SIMMs) (page 55) until no failure occurs. If replacing the SIMMs does not fix the problem, replace the system board (page 71).
B	Configured memory okay.	For VX41 and VX42 models, first replace the cache SIMM (page 56). If this does not fix the problem, continue with the recommended action for VX40 models. For VX40 models, replace memory modules (SIMMs) (page 55) until no failure occurs. If replacing the SIMMs does not fix the problem, replace the system board (page 71).
A	Testing 8M memory with internal data cache OFF and backup cache OFF.	For VX41 and VX42 models, first replace the cache SIMM (page 56). If this does not fix the problem, continue with the recommended action for VX40 models. For VX40 models, replace memory modules (SIMMs) (page 55) until no failure occurs. If replacing the SIMMs does not fix the problem, replace the system board (page 71).
9	Testing 8M memory with internal data cache OFF and backup cache ON.	For model VX40, replace the system board (page 71). For models VX41 and VX42, first replace the cache

Console Troubleshooting

Code	Description	Recommended Action
		SIMM (page 56). If replacing the cache SIMM does not fix the problem, replace the system board (page 71).
8	Testing 8M memory with internal data cache ON and backup cache OFF.	Replace the system board (page 71).
7	Testing 8M memory with internal data cache ON and backup cache ON.	For model VX40, replace the system board (page 71). For models VX41 and VX42, first replace the cache SIMM (page 56). If replacing the cache SIMM does not fix the problem, replace the system board (page 71).
6	Failed to find SIO while scanning PCI ID lines.	Replace the backplane (page 69). If a new backplane does not fix the problem, replace the system board (page 71).
5	Testing PCI data path using SIO.	Replace the backplane (page 69). If a new backplane does not fix the problem, replace the system board (page 71).
4	Testing flash ROM header. (Checks manufacturing code.)	Replace the system board (page 71).
3	Failed flash ROM size field out of range.	Replace the system board (page 71).
2	Testing flash ROM checksum (after loaded data).	Replace the system board (page 71).
1	Done with flash ROM load (either ROM0 or ROM2).	No action.
0	Jumping to SRM console prompt.	No action. If the SROM code is unable to load the Multia SRM console from flash ROM, or there is a checksum error after loading the flash code, then it attempts to load ARC from flash ROM. If SROM cannot load ARC, then an error code flashes on the back of the system box.

Console Troubleshooting

The Multia MultiClient Desktop contains two console firmware systems. The ARC console supports the Windows NT system and the SRM console is the Multia diagnostics console. The SRM console in the flash ROM contains manufacturing diagnostics.

If the system powers up but fails to boot and displays a crash dump, see the Machine Checks section.

Machine Checks

Symptom	Recommended Action
The system powers up but fails to boot, and a crash dump is displayed on your monitor.	For VX41 and VX42 models, first replace the cache SIMM (page 56). If this does not fix the problem, continue with the recommended action for VX40 models. For VX40 models, replace memory modules (SIMMs) (page 55)

Symptom	Recommended Action
	until no failure occurs. If replacing the SIMMs does not fix the problem, replace the system board (page 71).

Battery Problems

Symptom	Recommended Action
The system hangs, displaying the message <code>Setting console to boot mode.</code>	Replace the battery (page 73).
The system hangs after replacing the battery.	Replace the system board (page 71).

Boot Problems

Symptom	Recommended Action
The system cannot find the boot device.	<ol style="list-style-type: none"> 1. Check the system configuration for correct device parameters. 2. Use the ARC console to display the available boot devices. First, from the Boot menu, select the Supplementary menu..., then select list available boot devices. Verify that the target boot device is listed. 3. If the target boot device is not listed, try resetting the boot configuration (page 41).
Environment variables are incorrectly set. (For example, configuration settings may be lost if the battery or system board were replaced.)	<ol style="list-style-type: none"> 1. Check and set the environment variables, if necessary. 2. Check that the SCSI cable in the system box is properly connected.
The target boot device is not listed in the ARC's <code>list available boot devices</code> command, due to a SCSI bus problem.	<ol style="list-style-type: none"> 1. Make sure cables are oriented properly and connected. 2. Check for bent pins. 3. Check all the SCSI devices for incorrect or conflicting IDs. Refer to the device's documentation. 4. Check the SCSI bus termination. The SCSI bus must be terminated at the last internal and the last external SCSI peripherals. The last internal SCSI device automatically provides termination. <p>The external SCSI cabling must be less than 9 feet long.</p> <p>If no external SCSI cable or devices are plugged into the rear SCSI connector, the external portion is automatically terminated. If a SCSI cable is plugged in, then the automatic termination is disabled and the SCSI device must use a terminator.</p>

Network Problems

On power-up, the Ethernet LAN controller driver autosenses which of the three ports is connected. The default order of network detection is

1. Twisted pair
2. ThinWire
3. Thickwire

If there is no network connection, the LAN controller defaults to thickwire. If you change a network connection while the system is running, you have to reboot.

Symptom	Recommended Action
You cannot access network applications.	<ol style="list-style-type: none"> 1. Go to the SRM console. 2. At the >>> prompt, enter <code>SHOW DEVICE</code> You should see the following display: <pre>dka0.0.6.0 DKA0 TOSHIBA MK232FB A156 dva0.0.0.0.1 DVA0 ewa0.0.0.11.0 EWA0 08-00-2B-E2-C0-3B pka0.7.0.6.0 PKA0 SCSI Bus ID 7</pre> 3. If EWA0 is not in the list of devices, replace the system board (page 71). If EWA0 is in the list of devices, install JW thin AUI loopback connectors, and enter the following commands: <pre>>>> SET EWA0_MODE TWISTED >>> TUNET</pre> 4. Wait 30 seconds. If a failure occurs, replace the system board (page 71). If no failure occurs, continue with step 5. 5. Enter the following command: <pre>>>> EWA0_MODE AUI</pre> 6. Wait 30 seconds. If a failure occurs, replace the system board (page 71). If no failure occurs, continue with step 7. 7. Enter the following command: <pre>>>> SET EWA0_MODE THIN</pre> 8. Wait 30 seconds. If a failure occurs, replace the system board (page 71). If no failure occurs, continue with step 9. 9. Enter the following command: <pre>>>> SET EWA0_MODE AUTO</pre>

Symptom	Recommended Action
	<p>Caution</p> <p>Be sure to perform step 9. If you do not set EWA0_MODE to AUTO, all future Multia functions will fail.</p> <ol style="list-style-type: none"> Power down the Multia system. Remove loopback connectors. Connect the Multia system to the network. Power up the Multia system. At the >>> prompt, enter the following command: <pre>>>> TUNET</pre> Wait 30 seconds. <p>If a failure occurs, it is due to a problem with the building network or the cable between the Multia system and the building network.</p> <p>If no failure occurs, the network is operating properly.</p>

Memory Problems

Symptom	Recommended Action
<p>Various problems may indicate a problem with memory, such as the system is slow or the system displays less memory than you know is installed.</p>	<ol style="list-style-type: none"> Go to the SRM console. At the >>> prompt, enter the following command: <pre>>>> MEMORY</pre> <p>If no error occurs within 30 seconds, there are no problems with memory.</p> If an error occurs, replace the cache SIMM (page 56). If replacing the cache SIMM does not fix the problem, replace each memory module (SIMM) (page 55), one at a time, until the error is corrected. Make sure to use 72-pin, 70-nanosecond, JEDEC standard, 36-bit SIMMs. If the error continues to occur after replacing the SIMMs, replace the system board (page 71).

Floppy Drive Problems

Symptom	Recommended Action
<p>The floppy diskette is inaccessible for reading or writing during normal operation (Windows NT operating system running).</p>	<ol style="list-style-type: none"> Go to the SRM console. At the >>> prompt, enter SHOW DEVICE <p>You should see the following display:</p> <pre>dka0.0.6.0 DKA0 TOSHIBA MK232FB A156</pre>

Console Troubleshooting

Symptom	Recommended Action
	<pre>dva0.0.0.0.1 DVA0 ewa0.0.0.11.0 EWA0 08-00-2B-E2-C0-3B pka0.7.0.6.0 PKA0 SCSI Bus ID 7</pre> <p>3. If dva0 is not in the list of devices, first replace the floppy drive (page 65), then replace the cable.</p> <p>If dva0 is in the list of devices, install a FAT-formatted floppy diskette and enter the following command:</p> <pre>>>> FLOPPY</pre> <p>4. If an error occurs, try replacing each of the following parts in order, until the error is fixed:</p> <ol style="list-style-type: none"> Floppy disk drive cable (page 74) Floppy disk drive (page 65) System board (page 71)

SCSI Drive Problems

Symptom	Recommended Action
Your system fails to boot, and boot problems cannot be solved.	<ol style="list-style-type: none"> Go to the SRM console. At the >>> prompt, enter SHOW DEVICE <p>You should see the following display:</p> <pre>dka0.0.6.0 DKA0 TOSHIBA MK232FB A156 dva0.0.0.0.1 DVA0 ewa0.0.0.11.0 EWA0 08-00-2B-E2-C0-3B pka0.7.0.6.0 PKA0 SCSI Bus ID 7</pre> <ol style="list-style-type: none"> If PKA0 is not in the list of devices, then the SCSI chip is not being seen. <p>Remove the external SCSI device connection and type the SHOW DEVICE command again.</p> <ol style="list-style-type: none"> If the PK device is still not in the list of devices, replace the backplane (page 69). <p>Enter the SHOW DEVICE command again.</p> <ol style="list-style-type: none"> If PKA0 is still not in the list of devices, replace the system board (page 71). If PKA0 is in the list, but DKA0 is not, replace the hard drive: <ol style="list-style-type: none"> 2.5-inch (page 66) 3.5-inch, Alpha-based model (page 67) 3.5-inch, Intel-based model (page 69) <p>Enter the SHOW DEVICE command again.</p> If DKA0 is still not in the list of devices, replace the SCSI drive.

Thermal Problems

The Multia MultiClient Desktop operates in an ambient temperature range of 0° to 40° C. The system box is cooled by one automatic speed-controlled fan.

The power supply varies the fan voltage based on the feedback from a temperature sensor in the fan and speaker assembly.

Symptom	Recommended Action
Intermittent problems resulting from overheating.	<ol style="list-style-type: none"> 1. Make sure the airflow path is clear. 2. Make sure no materials are blocking the input grill. 3. Make sure the cables inside the system box are properly dressed and not impeding the airflow. 4. Make sure the fan is turning. You should hear it and detect airflow.

PCI Bus Error Detection

Not all PCI devices are required to detect and report parity errors, but all are required to generate parity on all of their transactions. The Multia MultiClient Desktop has parity disabled by default; do not enable it.

Accessing the Windows NT Event Logs

The Windows NT operating system maintains an event log file. The event logging service starts automatically when the Windows NT operating system is started. The Event Viewer lets you view and manage the event logs.

To start the Event Viewer

1. Press Ctrl + Esc to display the Task List.
2. In the New Task box, enter eventvwr.exe and choose Run.
3. Use the Log menu of the Event Viewer to select the log you need to view.

Windows NT uses three logs:

System log	Tracks events logged by Windows NT system components, such as the failure of a driver to load properly.
Application log	Tracks events logged by applications.
Security log	Tracks changes to the security system and identifies possible security breaches.

For more information, see the Event Viewer chapter in the *Microsoft Windows NT System Guide* or use the Event Viewer's online help on the Multia desktop.

3

Troubleshooting Intel-Based Models

Troubleshooting Overview

This chapter provides initial troubleshooting procedures and tables listing specific problems, probable causes, and recommended actions to take if your desktop fails after you configure it or after you install optional hardware or software.

Refer to the documentation supplied with additional options if you are experiencing problems with specific options that you have installed.

Initial Troubleshooting

Follow these general procedures to troubleshoot your Multia MultiClient Desktop for Intel.

- Press Ctrl + Alt + Del. If your desktop fails to boot, turn it off, wait until all hard disk drives completely spin down, and then turn it back on.
- If the power-on self-test (POST) detects an error, refer to POST Messages (page 25) and Beep Codes (page 27) and take the appropriate steps to correct the problem. After the problem has been resolved, restart the computer.
- If there are POST errors, run the BIOS Setup utility (page 44) and fix the problems identified by the POST errors.

Computer Troubleshooting

This section covers the following topics:

- No response when the computer is turned on.
- Power is on, but there is no screen display.
- Computer operates incorrectly after installation of option board.
- Computer operates incorrectly after installation of optional system memory (SIMMs).
- Computer fails to retain setup information.
- Computer does not boot from an IDE hard disk drive.
- Computer does not recognize an external SCSI device.
(If you have both IDE and SCSI hard disk drives installed, your computer uses the IDE hard disk drive as the boot device.)
- Computer does not boot from a target diskette drive.
- No response to keyboard commands.
- No response to mouse commands.

No response when the computer is turned on.

Probable Cause	Recommended Action
The computer is not plugged in.	Turn off the computer, plug it in, and then turn it back on again.
No power is at the wall outlet.	Use another wall outlet.
The system board failed.	Replace the system board (page 71).
The system board jumpers are incorrectly set.	Set all appropriate jumpers.
The power supply failed.	Replace the power supply (page 62).

Power is on, but there is no screen display.

Probable Cause	Recommended Action
The brightness and contrast controls are not correctly set.	Adjust the brightness and contrast controls.
The monitor is off.	Turn on the monitor.
The monitor-off timer has shut off the monitor.	Press the Shift key to reactivate the monitor.
The monitor cable is incorrectly installed.	Check all monitor connections.
The onboard video controller failed.	Replace the system board (page 71).
The monitor failed.	Replace the monitor.

Computer operates incorrectly after installation of optional expansion board.

Probable Cause	Recommended Action
The expansion board is installed incorrectly.	Remove the expansion board and reinstall.
The expansion board failed.	Remove the expansion board and reboot. If the computer boots without errors, replace the expansion board.

Computer operates incorrectly after installation of optional system memory (SIMMs).

Probable Cause	Recommended Action
The SIMMs are installed incorrectly.	Remove the SIMMs and reinstall (page 55).
The SIMMs have failed.	Remove the SIMMs and reinstall.
	Make sure slots (0 and 1) or (2 and 3) are filled with the correct SIMM size, speed, and type.
	Replace the SIMMs.

Computer fails to retain setup information.

Probable Cause	Recommended Action
The computer battery has failed.	Replace the computer battery (page 73).
The CMOS clear jumper (W6) is enabled.	Disable the CMOS clear jumper (W6).

Computer does not boot from an IDE hard disk drive.

Probable Cause	Recommended Action
The IDE drive type incorrect.	Run the BIOS Setup utility to identify the correct drive type. See the drive type label on the drive or consult the drive documentation.
The cables are loose.	Secure all cable connections.
The onboard IDE interface is disabled.	Run the BIOS Setup utility and set the IDE Hard Disk Drives option to Enabled.
The hard disk boot sector is missing.	Restore the Multia desktop to its initial software state (page 77). Replace the disk.
Operating system software is not installed on the IDE hard disk drive.	Install the appropriate operating system.
The IDE hard disk drive is not correctly formatted or the requested partition does not exist.	Format the IDE hard disk drive or partition the IDE hard disk drive using the supplied operating system software.
There is no software on the requested partition.	Install software on the requested partition.

Computer does not recognize an external SCSI device.

Probable Cause	Recommended Action
The SCSI device jumpers are incorrectly set.	Refer to the supplied SCSI device kit installation instructions.
A SCSI ID conflict exists.	Refer to the supplied SCSI device kit installation instructions on setting SCSI IDs.
The terminating resistors are not removed from the SCSI device.	Remove the terminating resistors. Refer to the supplied kit installation instructions.
The SCSI cable is not terminated.	Terminate each end of the SCSI cable.
The SCSI device is not plugged in.	Check the power and SCSI cables.
The SCSI cable is loose.	Secure all cable connections.

Computer does not boot from a target diskette drive.

Probable Cause	Recommended Action
The onboard diskette controller is disabled.	Run the BIOS Setup utility and set the diskette controller option to "Enabled."
The diskette drive is not enabled.	Run the BIOS Setup utility to enable the diskette drive.
The diskette drive type is incorrect.	Make sure the drive ID is correctly set (refer to the documentation supplied with your diskette drive).
The diskette boot option is disabled.	Run the BIOS Setup utility and set Boot From Diskette A to Enabled.
The diskette might not be bootable.	Use a bootable diskette.
The diskette does not contain startup files.	Insert a diskette with the correct startup files.
The diskette drive is empty.	Insert a diskette that contains an operating system.
The diskette is worn or damaged.	Try another diskette.
The cables are loose.	Secure all cable connections.

No response to keyboard commands.

Probable Cause	Recommended Action
The keyboard is not connected.	Power down the computer and connect the keyboard.
The keyboard is connected to the mouse port.	Power down the computer and connect the keyboard to the keyboard port.
The computer operation is halted.	Reboot the computer.

No response to mouse commands.

Probable Cause	Recommended Action
The mouse is not connected.	Power down the computer and connect the mouse.
The mouse is connected to the keyboard port.	Power down the computer and connect the mouse to the mouse port.
Computer operation is halted.	Reboot the computer.

Disk Drive Troubleshooting

This section covers the following topics:

- IDE/SCSI hard disk drive cannot read or write information.
- Target diskette drive cannot read or write information.

Monitor Troubleshooting

IDE/SCSI hard disk drive cannot read or write information.

Probable Cause	Recommended Action
The disk drive jumper settings are incorrect.	Refer to the supplied kit installation instructions.
The cables are loose or incorrectly installed.	Make sure all cables are correctly installed.
The IDE/SCSI hard disk drive is not correctly formatted or partitioned.	Format and partition the drive as required using the supplied operating system.
The IDE drive type is incorrect.	Run the BIOS Setup utility to identify the correct drive type.
The onboard IDE interface is disabled.	Run the BIOS Setup utility and set the IDE controller option to Enabled.

Target diskette drive cannot read or write information.

Probable Cause	Recommended Action
The diskette is not formatted.	Format the diskette.
The diskette is worn or damaged.	Try another diskette.
The diskette is write-protected.	Slide the write-protect switch so the hole is not visible (3.5-inch diskette).
The diskette drive is empty.	Insert a diskette.
The onboard diskette controller is disabled.	Run the BIOS Setup utility and set the diskette controller option to Enabled.

Monitor Troubleshooting

This section covers the following monitor problems:

- Monitor power indicator is not on.
- No screen display.
- No monitor display while loading Windows video drivers.
- Distorted, rolling, or flickering screen display, or wrong/uneven color.
- Monitor fails to switch to high-resolution mode.
- Monitor display not centered while loading Windows video drivers.

Monitor power indicator is not on.

Probable Cause	Recommended Action
The monitor is turned off.	Turn on the monitor.
The power cord is not connected.	Connect the power cord to the computer.
No power is at wall outlet.	Use another outlet.

Probable Cause	Recommended Action
The monitor-off timer shut off the monitor.	Press the Shift key to reactivate the monitor.

No screen display.

Probable Cause	Recommended Action
A configuration error has occurred.	Run the BIOS Setup utility to configure the computer for VGA operation.
The monitor power cable is loose or disconnected.	Secure or reattach the monitor power cable.
The monitor brightness and contrast controls are incorrectly set.	Adjust the monitor brightness and contrast controls.
The monitor-off timer shut off the monitor.	Press the Shift key to reactivate monitor.
The onboard video controller failed.	Replace the system board (page 71).

No monitor display while loading Windows video drivers.

Probable Cause	Recommended Action
The monitor type is incorrectly set.	Set the correct monitor type, using the appropriate utility. Also see any appropriate README files.
The wrong Windows driver is loaded.	Load the correct video driver.

Distorted, rolling, or flickering screen display, or wrong/uneven color.

Probable Cause	Recommended Action
The monitor is incorrectly adjusted.	Adjust the monitor accordingly.
The monitor signal cable is incorrectly installed.	Straighten any bent connector pins and reconnect the monitor signal cable.

Monitor fails to switch to high-resolution mode.

Probable Cause	Recommended Action
Appropriate high-resolution video drivers are not installed or are installed incorrectly.	Correctly install all appropriate high-resolution video drivers. See the documentation supplied with your monitor.
The video controller and/or monitor does not support the high-resolution mode that has been selected.	Check the system's README.TXT file and any information supplied with the monitor to determine an appropriate video resolution mode. Correctly set the video-resolution mode and install the appropriate video drivers.

Monitor display not centered while loading Windows video drivers.

Probable Cause	Recommended Action
The monitor type is incorrectly set.	Set the correct monitor type using the appropriate utility.
The monitor display is mis-adjusted.	Adjust the display using the monitor's adjustment controls.

Network Interface Troubleshooting

This section covers the following topics:

- Power is on, LAN address is installed on server; system hangs.
- Network does not start.

Power is on, LAN address is installed on server; system hangs.

Probable Cause	Recommended Action
The correct software is not installed on the server.	Contact your system administrator or network coordinator.

Network does not start.

Probable Cause	Recommended Action
The network cable is loose.	Secure the cable. Ensure that no more than one Ethernet cable is connected at one time.

Audio Troubleshooting

Probable Cause	Recommended Action
The sound, MIDI, or mixer drivers are not installed.	Check the error messages for the necessary drivers, and install the necessary drivers.
The cables are loose or not properly connected.	Make sure the speaker and microphone plugs are in the correct jacks. Reconnect the cables.

SCSI Device Troubleshooting

This section covers the following topics:

- Cannot access the CD-ROM drive. Error message reading drive *x*.
- Power is on but indicator shows no activity.
- Disc is spinning, but drive is idle.

Cannot access the CD-ROM drive. Error message reading drive x.

Probable Cause	Recommended Action
The device drivers are not installed.	Install the correct device drivers.
The CD-ROM drive is empty (no disc).	Insert a disc.
The tray is open.	Close the tray.
A SCSI ID conflict exists.	Check that the jumpers are properly set.

Power is on, but the indicator shows no activity.

Probable Cause	Recommended Action
The tray is empty (no disc) or open.	Insert a disc and close the tray.
The cable connections are loose.	Make sure the cables are correctly connected.

Disc is spinning but drive is idle.

Probable Cause	Recommended Action
The application software is not running.	Run the application software.

POST and Boot Messages

The power-on self test (POST) displays messages to alert you to errors in hardware, software, and firmware or to provide operating information about your computer.

Each time the POST displays a message on your screen, the computer's speaker beeps twice. If an error occurs before the monitor is initialized, specific beep codes sound to alert you to a problem.

POST and Boot Error Messages

Message	Problem	Solution
Diskette drive A error	The diskette drive failed.	Run the BIOS Setup utility. Check all connections. If the problem persists, replace the defective diskette drive, the drive cable, or both.
Extended RAM Failed at offset: <i>nnnn</i>	Extended memory failed or is configured incorrectly.	Make sure SIMMs are installed correctly. If the problem persists, replace defective SIMMs.
Failing Bits: <i>nnnn</i>	<i>nnnn</i> is a map of the bits at the RAM address that failed the memory test.	Run the BIOS Setup utility and restore all to original values. If the problem persists, replace the defective memory.

POST and Boot Messages

Message	Problem	Solution
Fixed Disk 0 Failure Fixed Disk 1 Failure Fixed Disk Controller failure	The hard disk drive, drive controller, or both failed.	Run the BIOS Setup utility. Check all connections. If the problem persists, replace the defective hard disk drive and/or controller.
Incorrect Drive A type - run SETUP	Diskette drive A is not correctly identified in the BIOS Setup utility.	Run the BIOS Setup utility and properly identify diskette drive A.
Invalid NVRAM media type	NVRAM access failed.	Run the BIOS Setup utility and restore all settings to original values. If the problem persists, replace the defective component.
Keyboard controller error Keyboard error Keyboard locked - Unlock key switch	The keyboard, keyboard controller, or both failed.	Check the keyboard connection. If the connection is secure, the keyboard or keyboard controller might have failed. If the problem persists, replace the defective keyboard, the controller, or both.
Monitor type does not match CMOS - Run SETUP	The monitor type is specified incorrectly.	Run the BIOS Setup utility and set the correct monitor type.
Operating system not found	The operating system cannot be found on drive A or drive C.	Run the BIOS Setup utility and correctly identify drive A or drive C. Correctly install the operating system. Refer to the supplied operating system documentation.
Press F1 to resume, F2 to Setup	This message appears after any recoverable error message.	Press F1 to reboot or F2 to enter the BIOS Setup utility to make any necessary changes.
Real time clock error	The real-time clock failed the BIOS test.	Replace real-time clock and then run the BIOS Setup utility to restore previous configuration information.
Shadow RAM Failed at offset: nnnn	Shadow RAM failed.	Run the BIOS Setup utility and disable failed shadow memory region.
System battery is dead - Replace and run SETUP	The battery or real-time clock failed.	Replace the battery (page 73) and then run the BIOS Setup utility to restore previous configuration information.
System cache error - Cache disabled	RAM cache failed.	Run the BIOS Setup utility and restore all settings to original values. If the problem persists, replace the defective cache memory (page 56).
System CMOS checksum bad - run SETUP	The battery failed.	Replace the battery (page 73).
System RAM failed at offset: nnnn	System RAM failed.	Run the BIOS Setup utility and restore all settings to original values. If the problem persists, replace the defective memory.

Message	Problem	Solution
System timer error	The computer's timer test failed.	Run the BIOS Setup utility and restore all settings to original values. If the problem persists, replace the defective component.
Invalid system configuration	The battery failed.	Run the BIOS Setup utility . From the Advanced Menu, choose reset configuration data. Choose yes to clear system configuration data.

POST and Boot Informational Messages

Message	Description
<i>nnnn</i> Cache SRAM Passed	Indicates how much cache memory (<i>nnnn</i> kilobytes) tested successfully.
Entering SETUP	BIOS Setup utility runs.
<i>nnnn</i> Extended RAM Passed	Indicates how much extended memory (<i>nnnn</i> kilobytes) tested successfully.
<i>nnnn</i> Shadow RAM passed	Indicates how much shadow RAM (<i>nnnn</i> kilobytes) tested successfully.
System BIOS shadowed	Indicates that your computer's BIOS was successfully copied to shadow RAM.
<i>nnnn</i> System RAM passed	Indicates how much system RAM (<i>nnnn</i> kilobytes) tested successfully.
UMB upper limit segment address: <i>nnnn</i>	Displays the address of the upper limit of UMB, indicating the released BIOS segments that can be reclaimed by a virtual memory manager.
Video BIOS shadowed	Indicates that your computer's video BIOS was successfully copied to shadow RAM.

Beep Codes

When POST finds an error and cannot display a message, the computer's speaker emits a series of beeps to indicate the error and places a value in I/O port 80h. During the POST, if the video configuration fails or if an external ROM module fails a checksum test, then your computer beeps three times (one long beep, and two short beeps).

The following table lists other fatal errors and their associated beep codes. Each code represents the number of short beeps that are grouped together. Fatal errors (errors that lock up your computer) are generally the result of a failed system board or some other add-on component (SIMM, BIOS, computer battery, and so forth).

Resolve any problems using the appropriate troubleshooting procedures.

Accessing the Windows NT Event Logs

Beep Code	Error Message	Port 80h
1-2-2-3	BIOS ROM checksum	16h
1-3-1-1	Test DRAM refresh	20h
1-3-1-3	Test keyboard controller	22h
1-3-4-1	Test 512K base address lines	2Ch
1-3-4-3	Test 512K base memory	2Eh
2-1-2-3	Check ROM copyright notice	46h
2-2-3-1	Test for unexpected interrupts	58h

Accessing the Windows NT Event Logs

See page 17.

Console Commands (Alpha-Based Models)

The Alpha-based Multia MultiClient Desktop provides two functional consoles:

- The ARC console supports the Windows NT operating system.
- The SRM console is the Multia diagnostics console.

The console firmware resides in 768 Kbytes of flash ROM on the system board. The flash ROMs may be updated in the field. This section describes

- ARC console commands
- SRM console commands
- Setting the default console to ARC or SRM
- Resetting the boot configuration

ARC Console Commands

The ARC console provides the following Boot menu. By default, the Multia MultiClient Desktop is set to autoboot 5 seconds after this menu appears.

```
ARC Multiboot Alpha AXP Version 3.5-x
Copyright (c) 1993 Microsoft Corporation
Copyright (c) 1993 Digital Equipment Corporation
```

Boot menu:

```
    Boot Windows NT
    Boot an alternate operating system
    Run a program
    Supplementary menu...
```

Use the arrow keys to select, then press Enter.

Boot Windows NT

The Boot Windows NT menu item causes the system to boot the default operating system. The boot selection identifier (Windows NT in this case) uses the current values selected in the Manage boot selections menu. The default boot selection identifier is whichever identifier is at the top of the identifier list.

When you boot the Windows NT operating system, you will see a display similar to the following:

ARC Console Commands

```
OS Loader V3.5
.....
Microsoft (R) Windows NT (TM) Version 3.5
1 System Processor [24552 Kb memory]
Checking file system on D:
The type of file system is FAT.
The volume is clean.
Checking file system on C:
The type of file system is FAT.
The volume is clean.
The screen then displays the Multia graphic and the Welcome box.
```

Boot an Alternate Operating System

This menu item lets you choose an operating system from a list of available boot selection identifiers.

To return to the Boot menu without making a selection, press Esc.

Run a Program

The Run a program menu item prompts you for a program to run. The program runs on top of the Windows NT firmware and must be linked in a special manner. For example, you can start the ARCINST formatting and partitioning program in this manner.

To return to the Boot menu without entering a program name, press Esc.

Supplementary Menu

Displays the Supplementary menu (page 30).

Supplementary Menu

```
ARC Multiboot Alpha AXP Version 3.5-9
Copyright (c) 1993 Microsoft Corporation
Copyright (c) 1993 Digital Equipment Corporation
```

Supplementary menu:

```
    Install new firmware
    Install Windows NT from CD-ROM
    Set up the system...
    Display hardware configuration
    Boot menu...
```

Use the arrow keys to select, then press Enter.

Install New Firmware

Do not select this menu item. This feature is not currently supported by the Multia MultiClient Desktop.

Install Windows NT from CD-ROM

Windows NT updates for Multia systems are distributed with Multia software updates, so normally there is no reason to use this menu item. Before selecting this item, insert the Windows NT distribution CD-ROM into a CD drive accessible to the system.

Set Up the System...

The Set up the system... menu item displays the Setup menu (page 31).

Display Hardware Configuration

The Display Hardware Configuration menu item displays a list of available hardware devices on your system. The list shows the controller, unit numbers, type of device, processor information, video option data, and PCI slot information.

Boot Menu

The Boot menu item returns you to the Boot menu.

Set Up Menu

You use the Setup menu to specify environment variables, configuration information, boot selections, and machine-specific setups.

The Setup menu also lets you switch to the SRM console for Multia diagnostics, by using the Switch to OpenVMS or Digital UNIX console menu item.

```
ARC Multiboot Alpha AXP Version 3.5.x
Copyright (c) 1993 Microsoft Corporation
Copyright (c) 1993 Digital Equipment Corporation
```

Setup menu:

```
    Set system time
    Set default environment variables
    Set default configuration
    Manage boot selection menu...
    Set system language
    Setup autoboot
    Machine specific setup...

    Edit environment variables
    Reset system to factory defaults

    Help
    Switch to OpenVMS or Digital UNIX console
    Supplementary menu and do not save changes

    Supplementary menu and save changes
```

Use the arrow keys to select, then press Enter.

Set System Time

The Set system time menu item lets you specify the current date and time.

Set Default Environment Variables

The Set default environment variables menu item lets you indicate the location of the default system partition and specify default environment variables.

Enter location of default system partition:

```
    Select media:
    SCSI Hard Disk
    Floppy Disk
    CD-ROM
```

After you select the media type, ARC prompts you for information such as the SCSI bus number, SCSI ID, and partition number.

ARC Console Commands

To return to the previous menu, press Esc.

Set Default Configuration

The Set default configuration menu item prompts you for the monitor resolution, floppy drive capacity, number of floppy drives, type of keyboard, and the SCSI host ID (typically 7).

Manage Boot Selection Menu

Displays the Boot selection menu (page 33).

Set System Language (ARC Version 3.10 and Later)

The Set system language menu is intended to allow you to choose the display language for ARC menus and messages. However, multiple language support is not available at this time. When the Set system language menu is displayed, choose the English (the default).

```
Current Language: English
Internal Firmware messages version 7.x
```

Select a default language:

```
English (US)
Other Language
```

Setup Autoboot

The Setup autoboot menu item lets you specify whether or not to boot the system automatically at power-up. If you select Yes, you also specify a countdown value in seconds. The countdown value indicates how long the Boot menu will appear on the screen before the automatic boot procedure begins. By default, the Multia MultiClient Desktop uses a countdown value of 5 seconds.

Machine Specific Setup

The Machine specific setup menu item displays the current status of the PCI parity-checking control — on or off. A menu lets you change the current setting or return to the Setup menu.

Use caution when making this selection. See PCI Bus Error Detection (page 17) for more information.

Edit Environment Variables

The Edit environment variables menu item displays the current settings for variables and lets you change the settings.

You use the up and down arrows keys to select a variable from the list for editing. The currently selected variable appears in the Name field. After you select a variable, press Enter to open the variable for editing. When you are finished editing a variable, press Enter.

To return to the previous menu, press Esc.

Reset System to Factory Defaults

For systems with ARC Version 3.10 or later, the Reset system to factory defaults menu item resets the environment, configuration, and boot selections to the default settings for Multia MultiClient Desktops. The command asks for confirmation that you want to do this.

For systems with ARC Version 3.5-7 or earlier, do not use the Reset to factory defaults menu item. To reset the system, see Resetting the Boot Configuration (page 41).

The ARC version number appears on the Boot menu.

Help

The Help menu item displays a single screen that provides basic setup steps and keyboard functions.

The help screen mentions the use of the Reset to factory defaults feature. Do not use this feature if your system has ARC Version 3.5-7 or earlier. To reset systems with ARC Version 3.5-7 or earlier, see *Resetting the Boot Configuration* (page 41).

Switch to the SRM Console (Multia Diagnostics)

The Switch to OpenVMS or Digital UNIX console menu item displays a menu that lets you switch from the ARC console to the SRM console at the next power-off/power-on cycle.

Which operating system should be launched at the next power cycle?

Boot selection is currently NT.

```
Switch to NT
Switch to OpenVMS
Switch to Digital UNIX
Setup menu...
```

Use the arrow keys to select, then press Enter..

Supplementary menu and save changes

The Supplementary menu and save changes menu item saves any configuration changes you have made and reboots the firmware.

This menu item is available only after you change configuration information.

Boot Selection Menu...

The Manage boot selection menu item displays the Boot selection menu. The Boot selection menu lets you maintain the list of boot selection identifiers.

```
ARC Multiboot Alpha AXP Version 3.5-x
Copyright (c) 1993 Microsoft Corporation
Copyright (c) 1993 Digital Equipment Corporation
```

Boot selection menu:

```
Add a boot selection
Change a boot selection
Check boot selections
Delete a boot selection
Dump boot selections
Rearrange boot selections
Setup menu...
```

Use the arrow keys to select, then press Enter.

Add a Boot Selection

The Add a boot selection menu item lets you add a boot selection identifier. For example, to make a new partition available for booting, select New system partition.

Change a Boot Selection

The Change a boot selection menu item lets you edit the environment variables for a boot selection.

SRM Console Commands

1. Choose the boot selection you want to edit, then press Enter.
2. Use the up and down arrow keys to choose the environment variable you want to edit, then press Enter.
3. Edit the variable, then press Enter.
4. Press Esc to return to the previous menu.

Check Boot Selections

The Check boot selections menu item performs a validity test on the available boot selections. If problems are detected, ARC gives you the option to ignore the problem, delete the selection, or change the selection.

Delete a Boot Selection

The Delete a boot selection menu item lets you delete any of the current boot selection identifiers. Use the up and down arrow keys to choose the boot selection identifier you want to delete, then press Enter.

Press Esc to return to the previous menu without deleting a selection.

Dump Boot Selections

The Dump boot selections menu item displays all boot selections.

Rearrange Boot Selections

The Rearrange boot selections menu item lets you reorder the list of boot selections. Use the up and down arrow keys to choose a selection. Press Enter to move that selection to the top of the list. The boot selection identifier at the top of the list becomes the default boot selection.

SRM Console Commands

This section describes some common SRM console commands you may use in diagnosing Multia MultiClient Desktops:

- Deposit
- Examine
- HD (hexadecimal dump)
- Show

The SRM console firmware supports many other commands. For a list of all available commands, type Help at the >>> prompt.

SRM Console Conventions

Item	Convention
Console prompt	>>>
Continuation line prompt	_>
Maximum command length	255 characters
Multiple contiguous spaces or tabs	Treated as a single space
Command abbreviations	Allowed, if not ambiguous
Command qualifiers or options	Prefix with a space and a dash (-)
Numbers	Hexadecimal, unless otherwise specified. Registers such as R0 to R31 are shown in decimal notation.

SRM Console Special Characters

Character/Keys	Function
Return	Terminates command line input.
← (Backspace)	Deletes the character that was previously typed.
Ctrl + A	Toggles insert/overstrike mode. (Overstrike is the default.)
Ctrl + B, ↑, or ↓	Recalls previous commands. (The last 16 commands are stored.)
Ctrl + C	Terminates the foreground process.
Ctrl + D or ←	Moves the cursor left one position.
Ctrl + E	Moves the cursor to the end of the line.
Ctrl + F or →	Moves the cursor right one position.
Ctrl + H	Moves the cursor to the beginning of the line.
Ctrl + O	Suppresses console output.
Ctrl + Q	XOFF. Resumes flow of data to the console.
Ctrl + S	XON. Stops the flow of data to the console.
Ctrl + U	Deletes the entire line.
Ctrl + R	Retypes the current command line.
Ctrl + P	In console mode, Ctrl P is ignored. In program mode, and if enabled, the software running is halted and the console firmware is started.

Specifying SRM Devices in Commands

Use the following command arguments to specify devices in SRM console commands:

Command Argument	Device	Comment
arcflash	ARC firmware	Contained in flash ROM 2. Use <code>examine</code> and <code>hd</code> only.
eerom	NVR (nonvolatile RAM)	
emem	EISA memory space	
eport	EISA I/O space	
fpr	Floating-point processor registers	
gpr	CPU general-purpose registers	
ipr	CPU internal processor registers	
pcmcia	PCMCIA controller registers	
pmem	Physical memory space	
pt	CPU PAL temporary registers	
rom0flash	Flash ROM 0	Use <code>examine</code> and <code>hd</code> only.
rom1flash	Flash ROM 1	Use <code>examine</code> and <code>hd</code> only.
rom2flash	Flash ROM 2	Use <code>examine</code> and <code>hd</code> only.

SRM Console Commands

Command Argument	Device	Comment
srmflash	SRM firmware	Contained in flash ROMs 0 and 1. Use <code>examine</code> and <code>hd</code> only.
toy	TOY (time-of-year)	
vmem	Virtual memory space	

Deposit Command

deposit [-{b,w,l,q,o,h}] [-{physical,virtual,gpr,fpr,ipr}] [-n *count*] [-s *step*]
 [*device:*]*address data*

Description

The deposit command writes data to an address that you specify. The address can be a memory location, register, device, or file.

Parameter	Meaning
-b	Byte of data.
-w	Word of data.
-l	Longword of data.
-q	Quadword of data.
-o	Octaword of data.
-h	Hexaword of data.
-physical	Reference physical address space.
-virtual	Reference virtual address space.
-gpr	Reference general purpose register address space.
-fpr	Reference floating point register address space.
-ipr	Reference internal processor register address space.
-n <i>count</i>	Specifies the number of consecutive locations to examine.
-s <i>step</i>	Specifies the address increment as a hexadecimal value. This option allows you to override the increment that is normally derived from the data size.
[<i>device:</i>]	Selects the device to access. See SRM Devices (page 35).
<i>address</i>	An address that specifies the offset within a device into which data is deposited. The address may also be any valid symbolic address:
	gpr-name Symbol representing General Purpose Register.
	ipr-name Symbol representing Internal Processor Register
	PC Program Counter
	+ The location immediately following the last location referenced by an examine or deposit.

Parameter	Meaning	
	-	The location immediately preceding the last location referenced by an examine or deposit.
	*	The location last referenced by an examine or deposit.
	@	The location addressed by the last location referenced by an examine or deposit.
<i>data</i>	The data to be deposited.	

Deposit Command Examples

Example	Meaning
>>>d -n 1FF pmem:0 0	Clear the first 512 bytes of physical memory.
>>>d -l -n 3 vmem:1234 5	Deposit 5 into four longwords starting at virtual memory address 1234.
>>>d -n 8 R0 FFFFFFFF	Loads GPRs R0 through R8 with -1.
>>>d -l -n 10 -s 200 pmem:0 8	Deposit 8 in the first longword of the first 17 pages in physical memory.
>>>d -b toy:0 0	Deposit 0 to location 0 in the time-of-year clock.

Examine Command

examine [-{b,w,l,q,o,h,d}] [-{physical,virtual,gpr,fpr,ipr}] [-n *count*] [-s *step*]
[*device:*]*address*

Description

The examine command displays the contents of an address you specify. The address can be a memory location, register, device, or file.

Parameter	Meaning
-b	Byte of data.
-w	Word of data.
-l	Longword of data.
-q	Quadword of data.
-o	Octaword of data.
-h	Hexaword of data.
-d	Display data as a decoded macro instruction.
-physical	Reference physical address space.
-virtual	Reference virtual address space.
-gpr	Reference general purpose register address space.

SRM Console Commands

Parameter	Meaning
-fpr	Reference floating point register address space.
-ipr	Reference internal processor register address space.
-n <i>count</i>	Specifies the number of consecutive locations to examine.
-s <i>step</i>	Specifies the address increment as a hexadecimal value. This option allows you to override the increment that is normally derived from the data size.
[<i>device:</i>]	Selects the device to access. See SRM Devices (page 35).
<i>address</i>	Specifies the address of the first location to examine within the current device.

Examine Command Examples

Example	Meaning
>>>e r0 gpr: 0(R0) 0000000000000002	Examine R0 by symbolic address.
>>>e -g 0 gpr: 0(R0) 0000000000000002	Examine R0 by address space.
>>>e gpr:0 gpr: 0(R0) 0000000000000002	Examine R0 by device name.
>>>examine pc gpr: 0000000F(PC) FFFFFFFC	Examine the program counter.
>>>examine -n 5 r7 gpr:00000007 (R7) 00000000 gpr:00000008 (R8) 00000000 gpr:00000009 (R9) 00000000 gpr:0000000A(R10) 00000000 gpr:0000000B(R11) 00000000 gpr:0000000C(R12) 00000000	Examine register 7 and the next five registers.
>>>examine ipr:11 ipr: 11 (KSP) 0000000000F4EB38	Examine internal processor register space at location 11.
>>>examine pmem:0 pmem: 0 0000000000000003	Examine physical memory at location 0.
>>>examine toy:0 toy: 0 0906400E0817140B	Examine the time-of-year clock at location 0.

HD (Hexadecimal Dump)

hd [-{byte,word,long,quad}] *file*

Description

The **hd** command dumps the contents of a specified file in hexadecimal and ASCII.

Parameter	Meaning
-byte	Displays data in byte sizes.
-word	Displays data by word.

Parameter	Meaning
-long	Displays data by longword.
<i>file</i>	Displays data by quadword.

HD Command Examples

```
>>>hd toy
```

```
00000000  2D 00 0A 00 00 00 02 02 00 00 26 46 00 80 FF FF  -.....&F....
00000010  FF FF FF FF FF FF 00 01 FF FF FF FF FF FF FF FF  .....
00000020  FF FF FF FF FF FF FF FF FF FF FF FF FF FF FF  .....
00000030  FF FF FF FF FF FF FF FF FF FF FF FF FF FF FF  03.....
```

```
>>>hd -b toy
```

```
00000000  36 00 0A 00 00 00 02 02 00 00 26 46 00 80 FF FF  6.....&F....
00000010  FF FF FF FF FF FF 00 01 FF FF FF FF FF FF FF FF  .....
00000020  FF FF FF FF FF FF FF FF FF FF FF FF FF FF FF  .....
00000030  FF FF FF FF FF FF FF FF FF FF FF FF FF FF FF  03.....
```

```
>>>hd -w toy
```

```
00000000  0039 000A 0000 0202 0000 4626 8000 FFFF  9.....&F....
00000010  FFFF FFFF FFFF 0100 FFFF FFFF FFFF FFFF  .....
00000020  FFFF FFFF FFFF FFFF FFFF FFFF FFFF FFFF  .....
00000030  FFFF FFFF FFFF FFFF FFFF FFFF FFFF 03FF  .....
```

```
>>>hd -l toy
```

```
00000000  000B0001 02020000 46260000 FFFF8000  .....&F....
00000010  FFFFFFFF 0100FFFF FFFFFFFF FFFFFFFF  .....
00000020  FFFFFFFF FFFFFFFF FFFFFFFF FFFFFFFF  .....
00000030  FFFFFFFF FFFFFFFF FFFFFFFF 03FFFFFF  .....
```

```
>>>hd -q toy
```

```
00000000  020200000000B0005 FFFF800046260000  .....&F....
00000010  0100FFFFFFFFFFFF FFFFFFFFFFFFFFFFFF  .....
00000020  FFFFFFFFFFFFFFFFFF FFFFFFFFFFFFFFFFFF  .....
00000030  FFFFFFFFFFFFFFFFFF 03FFFFFFFFFFFFFFFF  .....
```

Show Command

```
show [{device, hwrpb, memory, pal, version,...}] [envar]
```

Description

The show command displays the current value of a specified environment variable. The show command also displays information about the system, according to the arguments entered.

Parameter	Meaning
device [device name]	Displays the devices and controllers in the system. Specifying a device name returns information on that device only.
envar	Displays the value of the environment variable specified.
hwrpb	Display the Alpha HWRPB.

Setting the Default Console

Parameter	Meaning
map	Displays the system virtual memory map.
memory	Displays the memory module configuration.
pal	Displays the version of OpenVMS and Digital UNIX PALcode.
version	Displays the version of the console firmware.

Show Command Examples

Example	Output
>>>show device	dka0.0.0.6.0 DKA0 TOSHIBA MK2326FB A15B dva0.0.0.0.1 DVA0 ewa0.0.0.11.0 EWA0 08-00-2B-E2-C0-3B pka0.7.0.6.0 PKA0 SCSI Bus ID 7
>>>show memory	24 Meg of System Memory
>>>show version	V3.5-xx Nov 30 1994 18:22:35 xx represents a version number. For the Multia MultiClient Desktop, the first released version is 72.

Setting the Default Console

You can switch the default console from SRM (Multia style) to ARC (Windows NT style), or ARC to SRM.

From SRM to ARC

	Action	Response
1.	At the SRM prompt, enter the following command: >>>arc	The ARC console Boot menu appears. By default, the system autoboots after 5 seconds.

From ARC to SRM

	Action	Response
1.	Power on the desktop.	The ARC boot menu appears.
2.	Select the Supplementary menu.	The Supplementary menu appears.
3.	Select the Setup the system... menu.	The Setup the system menu appears.

Resetting the Boot Configuration

4.	Select Switch to OpenVMS or Digital UNIX console.	The following screen appears: Which operating system should be launched at the next power cycle? Boot selection is currently NT. Switch to NT Switch to OpenVMS Switch to Digital UNIX Setup menu... Use the arrow keys to select, then press Enter.
5.	Select Switch to Digital UNIX.	The current boot selection changes to Digital UNIX.
6.	Select Setup menu.	The Setup menu appears.
7.	Turn off the desktop.	
8.	Turn on the desktop.	>>>

Resetting the Boot Configuration

If the power-up sequence stops at the blue screen and displays an error message, you may need to reset the desktop to its default boot settings.

For systems with ARC Version 3.10 or later, use the Reset system to factory defaults menu item on the ARC boot menu. The ARC version number appears on the Boot menu.

For systems with ARC Version 3.5-7 or earlier, do not use the Reset to factory defaults menu item. To reset the system, use the following procedure:

1. Turn on the system box.
2. When the Boot menu appears, press an arrow key to stop the sequence. In the Boot menu, choose Supplementary menu:

```
Arc Multiboot Alpha AXP Version 3.5-7
Copyright (c) 1993 Microsoft Corporation
Copyright (c) 1993 Digital Equipment Corporation
```

```
Boot menu:
  Boot Windows NT
  Boot an alternate operating system
  Run a program
  Supplementary menu...
```

Use the arrow keys to select, then press Enter.

3. In the Supplementary menu, choose Set up the system:

```
Supplementary menu:
  Install new firmware
  Install Windows NT from CD-ROM
  Set up the system...
  Display hardware configuration
  Boot menu...
```

Use the arrows keys to select, then press Enter.

Resetting the Boot Configuration

- The first three items in the Setup menu will be yellow.

Setup menu:

```
Set system time
Set default environment variables
Set default configuration
Manage boot selection menu...
Setup autoboot
Machine specific setup...

Edit environment variables
Reset system to factory defaults

Help
Switch to OpenVMS or Digital UNIX console
Supplementary menu, and do not save changes...
```

Use the arrow keys to select, then press Enter.

- Complete the three yellow items *in order*.

- Set the system time:

```
Enter the new date (mm-dd-yy) : 10-5-94
Enter time (hh:mm:ss) : 1:22:40
```

- Set the default environment variables, as follows. Select the SCSI hard disk.

Enter location of default system partition:

```
    Select media:
    SCSI Hard Disk
    IDE Hard Disk
    Floppy Disk
    CD-ROM
    Enter SCSI bus number: 0
    Enter SCSI ID: 0
    Enter partition (must be FAT or NTFS): 1
```

- Set the default configuration, as follows:

```
Select monitor resolution:
1280x1024
1024x768
800x600
640x480
```

Select first floppy drive capacity:

```
5.25" 1.2MB
3.5" 1.44MB      (If you have floppy drive)
3.5" 2.88MB
None             (If you do not have a floppy drive)
```

Select second floppy drive capacity:

```
5.25" 1.2MB
3.5" 1.44MB
3.5" 2.88MB
None
```

Select keyboard:

```
U.S.      101-key keyboard (Select your keyboard)
Japanese 106-key keyboard
French    102-key keyboard
German    102-key keyboard
Spanish   102-key keyboard
...
```

Enter SCSI Host ID (0 -7) for SCSI bus number 0 : 7

Resetting the Boot Configuration

- The Setup menu appears again. Choose the Manage boot selection menu.

In the Boot selections menu, choose Add a boot selection:

Boot selections menu:

```
Add a boot selection
Change a boot selection
Check boot selections
Delete a boot selection
Dump boot selections
Rearrange boot selections
Setup menu...
```

Use the arrow keys to select, then press Enter.

- Choose the following settings:

Select a system partition for this boot selection:

```
SCSI Bus 0 Hard Disk 0 Partition 1
New system partition
```

Enter the osloader directory and name:

```
\os\winnt\osloader.exe
```

Is the operating system in the same partition as the osloader:

```
Yes
No
```

Enter location of os partition:

```
Select media:
SCSI Hard Disk
IDE Hard Disk
Floppy Disk
CD-ROM
```

```
Enter SCSI bus number: 0
```

```
Enter SCSI ID: 0
```

```
Enter partition: 2 (Change from the default of 1)
```

Enter the operating system root directory: **\winnt35** (Add the "35")

Enter a name for this boot selection: **Windows NT**

Do you want to initialize the debugger at boot time?

```
Yes
No
```

- The Boot selections menu appears again. Choose Check boot selections to verify your settings. If an error appears, start the procedure again.

- Choose Setup menu to return to the Setup menu.

- In the Setup menu, choose Setup autoboot.

Should the system autoboot:

```
Yes
No
```

```
Enter the countdown value (in seconds): 3
```

- The Setup menu appears again. Choose Supplementary menu, and save changes. The system should autoboot.

5

BIOS Setup Utility (Intel-Based Models)

This chapter provides information on how to use the BIOS Setup utility to change configuration settings when required, such as after installing a hardware option. The Multia desktop comes preconfigured, so no initial setup is required. You can also use the BIOS Setup utility to reset the desktop to its default configuration, if problems occur.

- Running the BIOS Setup Utility
- Navigating in the BIOS Setup Utility
- BIOS Setup Utility Options
- Resetting the Boot Configuration

Running the BIOS Setup Utility

The BIOS Setup utility lets you specify operating settings and permanently store information about the computer's hardware and software in the battery-backed memory of the CMOS RAM. This information takes effect each time the computer boots. You can access the utility and change settings whenever you restart the desktop.

Use the BIOS Setup utility to resolve problems with the hard disk or to reconfigure the desktop. You also may need to change settings after adding or removing hardware, or after changing certain software settings.

To run the BIOS Setup utility

1. Turn on the desktop.
2. Before the power-on self test (POST) completes, press F2 to display the main menu.
3. When selecting settings, refer to this chapter and the online help for each menu option.

Navigating in the BIOS Setup Utility

The following sections provide some helpful hints for navigating in the BIOS Setup utility:

- Shortcut Keys
- Item-Specific Help
- Navigating Between Menus
- Exit Menu Options

Shortcut Keys

The main menu lists function keys and numeric keypad keys you can use to navigate menus, select options, and change settings. You can also view the list of keys from the General Help popup screen.

Item-Specific Help

When you highlight an option, the BIOS Setup utility displays help for that option on the right side of the screen.

Navigating Between Menus

Use the left and right arrow keys to move between menus.

Pressing Esc in a submenu returns you to the main menu.

Pressing Esc in the main menu displays the exit menu.

Exit Menu Options

- Select Save Changes & Exit to save all Setup values.
- Select Discard Changes & Exit to exit Setup without recording any changes.

Caution

When you select this option, a warning appears advising you that you have not saved any changes to your Setup settings. You are asked whether you want to save changes to your Setup settings. Answer **Yes** (the default setting) to save changes; answer **No** to exit without saving changes.

- Select Get Default Values to set all Setup options to their default values.
- Select Load Previous Changes to restore all CMOS values from the last session.
- Select Save Changes to save all selections without exiting Setup.

BIOS Setup Utility Options

The following sections describe the options under each menu in the BIOS Setup utility.

- Main Menu Options set basic computer configuration options (such as time and date).
- Advanced Options set advanced features to increase computer performance (such as COM port and LPT port settings).
- Security Options let you set a supervisor password and backup data reminders.
- Power Options set power-saving options to increase the life of your desktop.
- Exit provides options for saving changes and leaving BIOS Setup. See the previous section.

Main Menu Options

Menu Fields	Settings	Comments
System Time	Current time	Sets the current time.
System Date	Current date	Sets the current date.
Language	English Español Français Deutsch	Sets the display language for the BIOS Setup utility.
Diskette A Diskette B	1.44 MB, 3½ 2.88 MB, 3½ Not Installed 1.2 MB, 5¼ 720 KB, 3½	Sets the size and density of diskette drives. The Multia desktop uses only one diskette drive.
IDE Adapter 0 Master IDE Adapter 0 Slave		See IDE Hard Disk Options (page 46).
Video system	EGA / VGA CGA 80x25 Monochrome	Sets the video controller type.
Memory Cache		See Memory Cache Options (page 47).
Memory Shadow		See Memory Shadow Options (page 47).
Boot Sequence		See Boot Options (page 48).
Numlock		See Keyboard Options (page 48).
System memory	Not user selectable	Displays the amount of base (conventional) memory each time the computer boots.
Extended memory	Not user selectable	Displays the amount of extended memory each time the computer boots.

IDE Hard Disk Options

Menu Fields	Settings	Comments	
Autotype fixed disk		Press Enter to detect and fill in the installed hard disk drive parameters in the remaining fields.	
Type	Auto None to 39 User	Selecting a number (1 to 39) automatically fills in the remaining fields in this menu. Select User if you want to fill in the remaining fields manually, using the installed hard disk drive's parameters.	Note 1
Cylinders	0 to 4095	Displays the number of cylinders.	Note 2
Heads	1 to 64	Displays the number of heads.	Note 2
Sectors/track	0 to 63	Displays the number of sectors/track.	Note 2
Write precomp	0 to 4095 None	Displays the number of cylinders that have their write timing changed.	Note 1
Multi-sector transfers	2 sectors 4 sectors 8 sectors 16 sectors Auto Disabled	Determines the number of sectors per block for multiple sector transfers. Auto refers to the size the disk returns when queried.	

Menu Fields	Settings	Comments
LBA mode control	Disabled Enabled	Enables or disables the LBA hard disk drive addressing option. This option allows you to select Disabled for IDE hard disk drives up to 528 MB. When using IDE drives greater than 528 MB and MS-DOS or Windows as your operating system, select Enabled. Select Disabled for all other operating systems
32 Bit I/O	Enabled Disabled	Enables or disables 32-Bit data transfer with the IDE hard disk drive. This setting is recommended when using the PCI IDE connector.
Transfer Mode	Standard Fast PIO1 Fast PIO2 Fast PIO3 Fast PIO4	Selects the method to transfer data to and from the IDE hard disk drive. If you select Auto in the Type field, Setup automatically selects the optimum transfer mode.

Note 1

These fields are automatically filled in if the desktop autodetected an installed hard disk drive 49. Incorrect settings can cause the desktop to malfunction.

Note 2

These fields are automatically filled in if the computer autodetected an installed hard disk drive 49.

Memory Cache Options

Menu Fields	Settings	Comments
External Cache	Enabled Disabled	Enables your desktop's external cache to operate in write-back mode. For optimal computer performance, keep this setting at Enabled.
Cache System BIOS	Enabled Disabled	Enables the system BIOS to be cached in the internal cache and external cache (if installed). This increases computer performance, because BIOS instructions can execute in cache instead of RAM.
Cache Video BIOS	Enabled Disabled	Enables the video BIOS to be cached in the internal cache and external cache (if installed). This increases computer performance because video BIOS instructions can execute in cache instead of RAM.
Cache Memory Region: C800 - CBBF CC00 - CFFF D000 - D3FF D400 - D7FF D800 - DBFF DC00 - DFFF	Enabled Disabled	Enables or disables shadowing of individual segments of ROM, to increase computer performance.

Memory Shadow Options

Menu Fields	Settings	Comments
System BIOS shadow	Enabled (permanently set)	The system board reserves an area of DRAM for a copy of system BIOS ROM. This DRAM, called shadow memory, is write-protected and has the same addresses as the system BIOS ROM locations. When system BIOS ROM is shadowed, the ROM information is copied into an appropriate area in DRAM. This increases the computer's performance, because the system BIOS instructions are in fast DRAM instead of ROM.
Video BIOS shadow	Enabled Disabled	The system board reserves an area of DRAM for a copy of video BIOS ROM. This DRAM, called shadow memory, is write-protected and has the same addresses as the video BIOS ROM locations. When video BIOS ROM is shadowed, the ROM information is copied into an appropriate area in DRAM. This increases the computer's performance, because the video BIOS instructions are in fast DRAM instead of ROM.

Boot Options

Menu Fields	Settings	Comments
Boot Sequence	A: then C: C: then A: C: only	Each time the computer boots, it loads the operating system from the sequence selected.
SETUP Prompt	Enabled Disabled	Enables or disables the F2 Setup prompt each time the desktop boots. Selecting <i>Disable</i> only disables the prompt that indicates when to press F2 to enter Setup. You can still enter Setup by pressing F2 before the POST completes.
POST Errors	Enabled Disabled	Enabling this option causes the desktop to pause and display a setup entry or resume the boot prompt if an error occurs at boot. Disabling this option causes the desktop to always attempt to boot, regardless of a setup entry or error.
Floppy Check	Enabled Disabled	Enabling this option causes the desktop to verify the diskette type each time the desktop boots. Disabling this option speeds up the boot process.
Summary Screen	Enabled Disabled	Enabling this option causes the desktop to display configuration parameters in the form of a summary screen during the boot process.

Keyboard Options

Menu Fields	Settings	Comments
Numlock	Auto* On Off	Turns NumLock on or off each time the computer boots.

Menu Fields	Settings	Comments
Key Click	Disabled Enabled	Enables or disables the audible key click feature.
Keyboard Auto-repeat Rate	2/sec 6/sec 10/sec 13.3/sec 18.5/sec 21.8/sec 26.7/sec 30/sec	Sets the number of times a second to repeat a keystroke while the key is held down.
Keyboard Auto-repeat Delay	1/4 sec 1/2 sec 3/4 sec 1 sec	Sets the delay time after a key is held down before it begins to repeat a keystroke.
* If you select Auto, the desktop turns on NumLock if it detects a numeric keypad.		

Advanced Options

Menu Fields	Settings	Comments
Integrated Peripherals		See Integrated Peripherals (page 49).
Advanced Chipset Control		See Advanced Chipset Control (page 50).
Plug & Play O/S	Yes No	This option is for a Plug & Play operating system, such as Windows 95. The Multia desktop uses the Windows NT Workstation operating system, so use the No setting.
Reset Configuration	Yes No	Select Yes to clear the system configuration data if you suspect it is corrupted, which sometimes occurs after a power outage. This option also clears the Plug & Play databases. After you input correct settings (or accept the default settings), the computer switches this setting back to No. If you do not need to clear system configuration data, leave the setting at No.
Large Disk Access Mode	DOS Other	Select DOS if you have MS-DOS installed. Select Other if you have another operating system installed. A large disk drive is a drive that has more than 1024 cylinders, 16 heads, or 63 tracks per sector.

Integrated Peripherals

Menu Fields	Settings	Comments
LPT Port	Auto Disabled 3BC, IRQ 7 378, IRQ 7 278, IRQ 5	Enables or disables the onboard port at the specified address. Two devices cannot share the same IRQ.
LPT Mode		Sets the onboard parallel port mode:

BIOS Setup Utility Options

Menu Fields	Settings	Comments
	Output Only	Output only mode.
	Bi-directional mode	PS/2 compatible mode and able to receive data.
	ECP mode	Extended capabilities port mode.
COM Port	Auto Disabled 3F8, IRQ 4 2F8, IRQ 3 3E8, IRQ4 2E8, IRQ3	Enables or disables onboard serial port 1 at the specified address. Select Auto unless interrupts IRQ4 and/or IRQ3 are allocated as a computer resource. If you select Auto , Setup configures COM1 to address = 3F8h and IRQ = 4. Two devices cannot share the same IRQ.
COM Port	Auto Disabled 3F8, IRQ 4 2F8, IRQ 3 3E8, IRQ4 2E8, IRQ3	Enables or disables onboard serial port 2 at the specified address. Select Auto unless interrupts IRQ4 and/or IRQ3 are allocated as a computer resource. If you select Auto , Setup configures COM2 to address = 2F8h and IRQ = 3. Two devices cannot share the same IRQ.
Diskette Controller	Enabled Disabled	Enables or disables the onboard diskette controller.
IDE Adapter	Enabled Disabled	Enables or disables the onboard IDE controller.

Advanced Chipset Control

Caution

The advanced chipset control options should normally stay at their default values. Change them only if necessary to correct specific operating problems or errors.

Menu Fields	Settings	Comments
DRAM Speed	70 ns 60 ns	Displays the speed of the SIMMs installed. Used to configure the system for maximum performance.
DRAM Aliasing	Enabled Disabled	Disable DRAM aliasing if a device exists on the ISA bus which uses I/O ports 90h, 94h to 96h, 98h, 9Ch to 9Eh.
8-bit I/O Recovery	4.5 5.5 to 11.5	Specifies ISA clock signals inserted between back-to-back I/O.
16-bit I/O Recovery	4.5 5.5 to 11.5	Specifies ISA clock signals inserted between back-to-back I/O
IRQ12 Used by	PS/2 Mouse ISA Bus	Routes interrupt request 12 (IRQ12) from the PS/2 mouse or ISA bus to the PIC.

Security Options

You can restrict access to the BIOS Setup utility by setting supervisor and user passwords.

- Using the **supervisor** password provides full access to all BIOS Setup utility menus.
- Using the **user** password restricts access to certain BIOS Setup utility menus. To delete or disable the user password, press Enter in the Set User Password field. When prompted for the user password, leave the field blank and press Enter again.

Menu Fields	Settings	Comments
Supervisor Password is	Disabled Enabled (not user selectable)	Indicates whether or not the supervisor's password is enabled or disabled.
User Password is	Disabled Enabled (not user selectable)	Indicates whether or not the user's password is enabled or disabled.
Set Supervisor Password	Press [Enter]	Lets you specify a supervisor password to restrict access to the BIOS Setup utility. You must set a supervisor password before you can set a user password. Entering BIOS Setup with a supervisor password provides access to all user-selectable features
Set User Password	Press [Enter]	Lets you specify a user password for entering the BIOS Setup utility. You must specify a supervisor password first. Entering BIOS Setup with a user password provides access to the following information: Supervisor password is Enabled. User password is Enabled. Set user password [press enter] to enter a user password. Password on boot Enabled/Disabled (whichever is in effect). You cannot change this option setting.
Password on boot	Enabled Disabled	Enables or disables the enter password on boot option.
Diskette access	Supervisor User	Controls who has access to diskette drives. If Supervisor is selected, access to the diskette drive is limited to the supervisor, who must enter his or her password. If User is selected, the diskette drive can be accessed by entering either the supervisor or the user password. Whatever setting is chosen, it only becomes functional if both a Supervisor Password and a User Password have been set (if you choose User for the setting).
Fixed disk boot sector	Normal Write protect	Write-protects the boot sector on your hard disk drive.
Network server	Enabled Disabled	This option keeps the computer from being accessed during network operation.
System backup reminder	Disabled Daily Weekly Monthly	Enables or disables the system backup reminder message.

BIOS Setup Utility Options

Menu Fields	Settings	Comments
Virus check reminder	Disabled Daily Weekly Monthly	Enables or disables the virus check reminder message.

Power Options

Menu Fields	Settings	Comments
APM	Enabled Disabled	Allows Advanced Power Management (APM) software to better manage power savings.
Power Savings	Customize Max. Power Savings Med. Power Savings Med. Power Savings Disabled	Select Customize if you want to make your own selections in the other menu fields. Max., Med., and Min. set power management options to predefined values.
Standby Timeout	2 min. 15 min. 30 min 1 hr. 2 hr. 3 hr. 4 hr	Specifies how long the desktop must be inactive before a partial power shutdown takes effect. In a partial power shutdown, the monitor and CPU are set to power management. Any mouse or keyboard activity quickly returns the desktop to operation. You must enable power management to use this option.
Suspend Timeout	2 min. 15 min. 30 min 1 hr. 2 hr. 3 hr. 4 hr	Specifies how long the desktop must be inactive before a maximum power shutdown takes effect. In a maximum power shutdown, the monitor, CPU, and hard disk are powered down. Any mouse or keyboard activity quickly returns the computer to operation. You must enable power management to use this option.
Standby CPU Speed	MAX HIGH MED LOW	Sets the CPU speed during standby mode. MAX = full speed, HIGH = 1/4 speed, MED = 1/8 speed, LOW = 1/16 speed.
Fixed Disk Timeout	Disabled 1 min to 5 min 10 min 16 min	Specifies how long the fixed disk drive must be inactive (motor off) before standby mode takes effect.
CRT	On Off in Standby	Enables or disables the monitor display during standby mode.

Resetting the Boot Configuration

To reset the desktop to its default boot configuration settings

1. Turn on the system box.
2. When the BIOS screen messages appear, press F2 to enter the Setup utility.
3. In the Setup window, use the arrow keys to choose the Exit screen.
When you move the cursor to a new screen item, help appears on the right.
4. In the Exit screen, choose Get Default Values.
Then choose Save Changes and Exit.
5. The system should autoboot. An OS Loader screen appears after the Setup utility. If the boot process stops at the OS Loader screen, choose Windows NT.

Notes on the Setup Utility and OS Loader

- By default, the Power Management and Power Savings options on the Advanced screen are disabled. Leave these options disabled, because the Windows NT operating system currently does not support these features.
- By default, the desktop uses a video resolution setting of 1024 x 768. If you choose the Windows NT (VGA mode) option on the OS Loader screen, the system starts in VGA mode with a screen resolution of 640 x 480.

6

Removing and Replacing FRUs

Before You Start

This chapter describes how to remove field replaceable units (FRUs). The procedures apply to both Alpha- and Intel-based models, unless indicated otherwise.

- Memory modules (SIMMs)
- Cache memory SIMM (models VX41, VX42, VX51)
- Alpha processor upgrade (models VX41 and VX42)
- Intel processor upgrade (model VX51)
- PCI option
- Power supply
- Floppy disk drive
- Floppy disk drive cable
- 2.5-inch hard disk drive
- 3.5-inch hard disk drive (Alpha-based models)
- 3.5-inch hard disk drive (Intel-based models)
- Backplane
- System board
- Batteries
- Speaker

Caution

Static electricity can damage integrated circuits. Always use a static protection kit (29-26246-00) when handling any internal components.

Replacing FRUs

To replace a FRU, reverse the steps in the FRU's removal procedure. After replacing a FRU, reconnect external cables and components.

Accessing the Component Drawer

1. Perform an orderly shutdown of the desktop.
 - a. Click the Multia logo in the desktop's Application Manager.
 - b. Choose Shutdown from the menu.
2. Turn off the power switch on the system box and monitor.
3. Unplug the ac power cord from each power supply.
4. Disconnect all cables from the rear of the system box.
5. Unscrew the two captive screws at the rear of the system box.
6. Slide the component drawer partway out and disconnect connectors P8 and P9. Then slide the drawer all the way out.

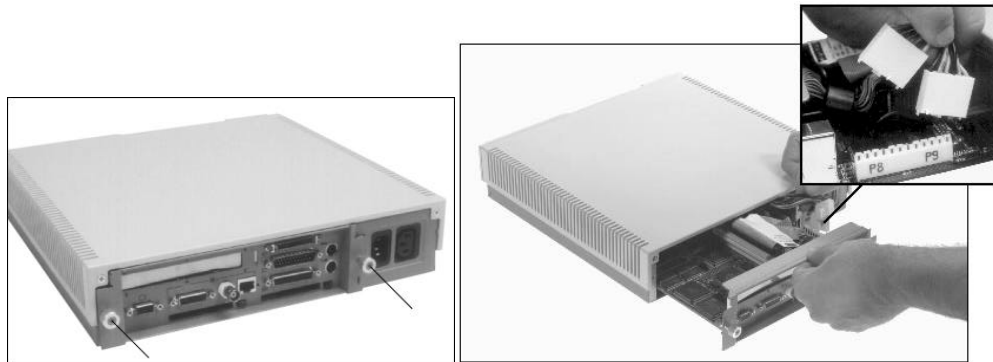

Memory Modules (SIMMs)

Memory modules are always used in pairs. See SIMM Configuration (page 6).

If you remove and replace the same modules, make sure to replace them in their original slots.

To remove memory modules

1. Slide out the component drawer and locate the SIMMs.
2. Release the two clips for a SIMM by gently pulling each clip to the side.
3. Tilt the SIMM forward as shown and lift the SIMM out of its connector.

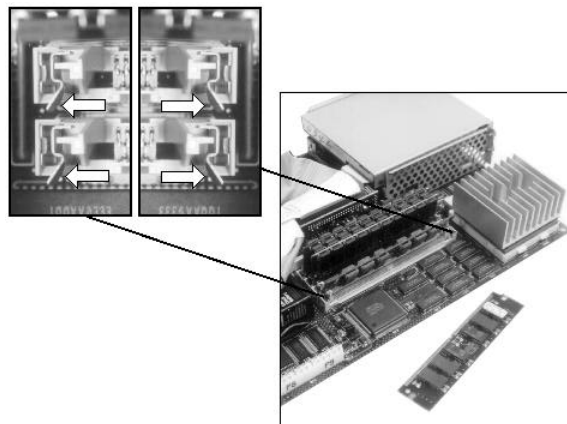

Cache Memory

To replace memory modules

1. Make sure the SIMM's notch is aligned with its connector.
2. Insert the SIMM into its connector at a 45-degree angle.
3. Raise the SIMM to a vertical position, until both clips hold the SIMM in place.

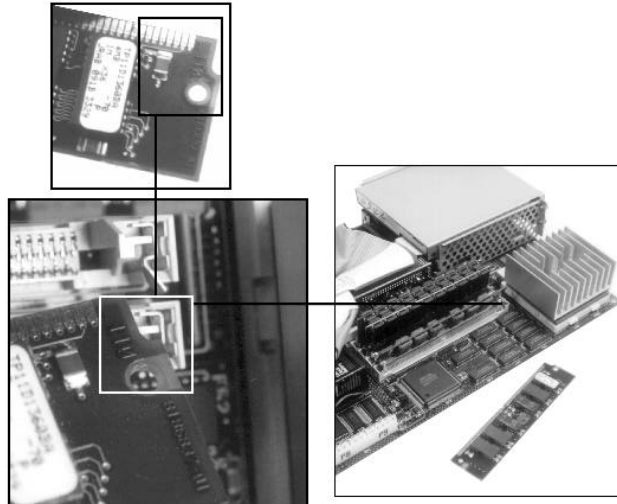

Cache Memory

All models except the VX40 have an upgradable cache memory module.

To remove the cache memory option

1. Slide out the component drawer.
2. Lift the cache memory straight up and out of its slot.

The cache memory option occupies the inside SIMM slot, near the center of the system board. On Intel-based models, the slot is offset from the other SIMM slots.

Alpha-based model shown

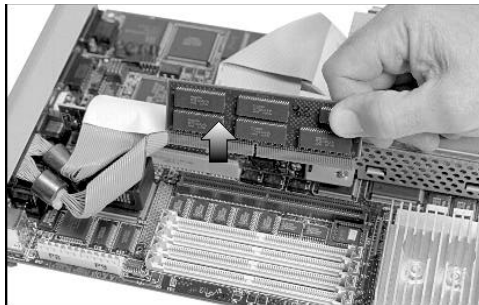

To replace the cache SIMM

Align the cutout in the center of the SIMM with the center of the slot.

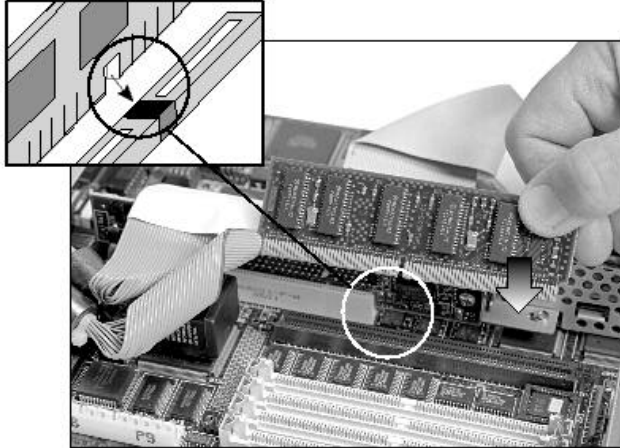

Alpha Processor Upgrade

All Alpha-based models except the VX40 have an upgradable Alpha processor.

To remove the Alpha processor

1. Slide out the component drawer.
2. Release the handle for the Alpha processor by pressing the handle down and out, then lift the handle up.

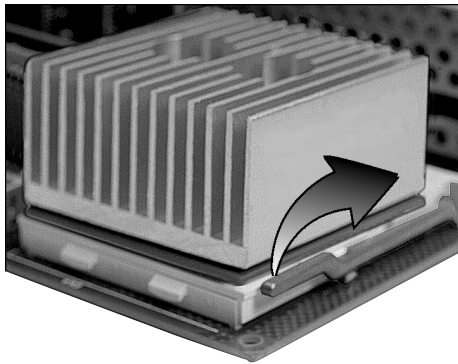

3. Lift the Alpha processor straight up and out of its socket.

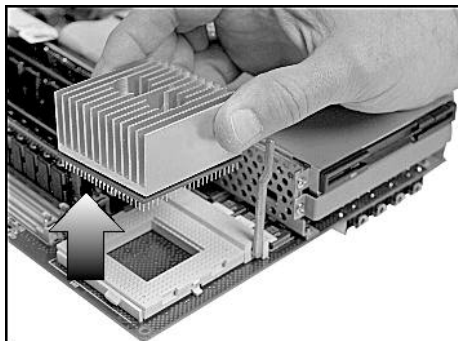

Alpha Processor Upgrade

To replace the Alpha processor

1. Align the beveled corner of the Alpha processor with the inside corner of its slot.

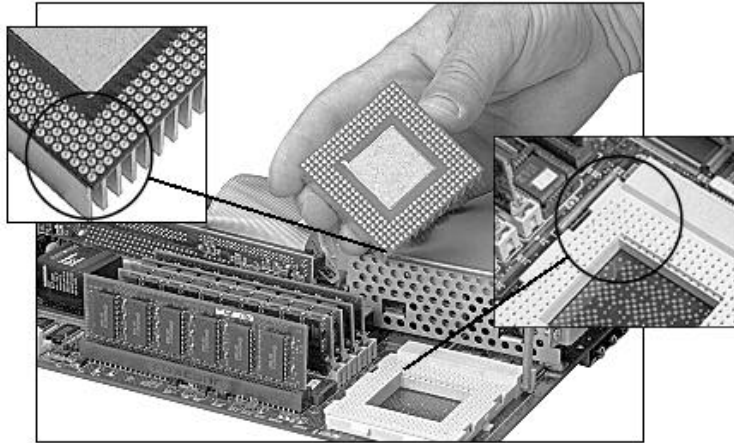

2. Lower the Alpha processor straight down into its slot, then lower the slot's handle and lock in place.

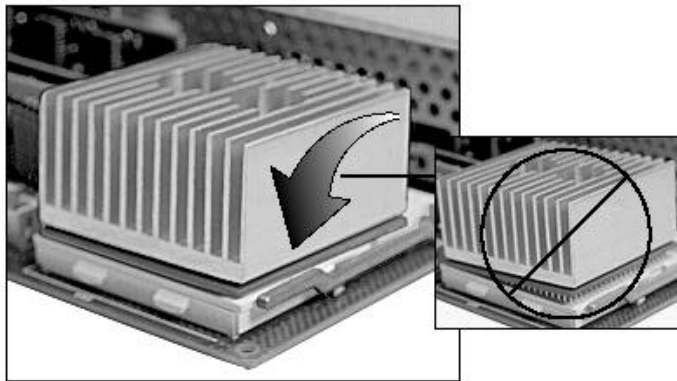

3. Set the W7, W8, and W9 jumpers based on the Alpha processor installed. The jumpers are in front of the SIMM memory modules, at the edge of the system board. See the System Board Jumpers section for settings.

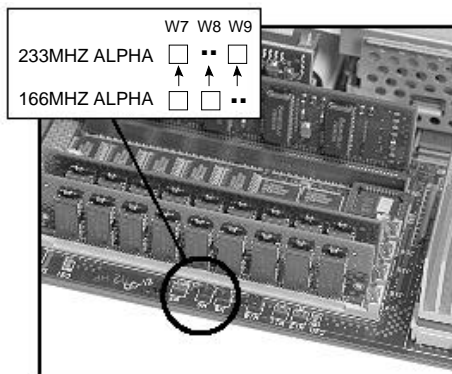

Intel Processor Upgrade

All Intel-based models have an upgradable Pentium processor.

To remove the Intel processor

1. Slide out the component drawer.
2. Release the handle for the Intel processor by pressing the handle down and out, then lift the handle up.

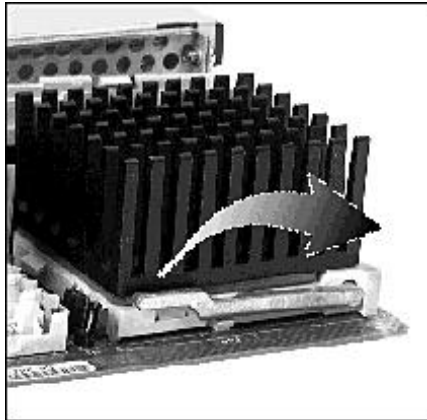

3. Lift the Intel processor straight up and out of its socket.

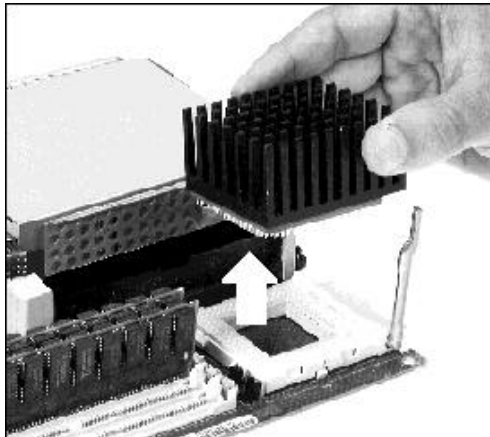

Intel Processor Upgrade

To replace the Intel processor

1. Align the beveled corner of the Intel processor with the inside corner of its slot.

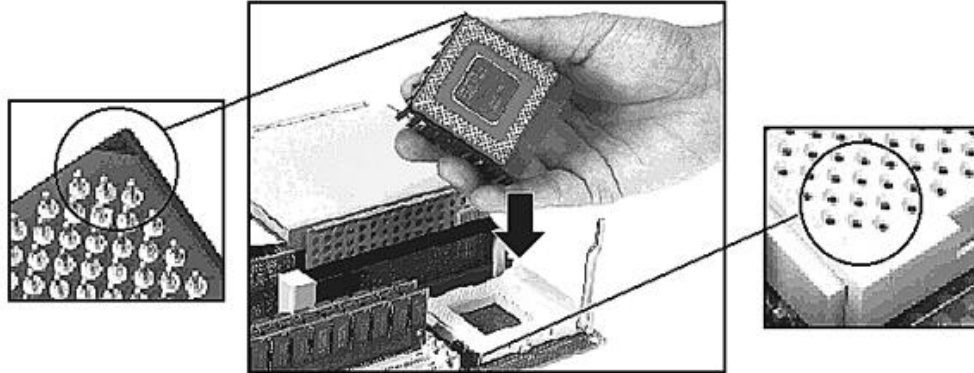

2. Lower the Intel processor straight down into its slot, then lower the slot's handle and lock in place.

Jumper W2 is shown for the next step.

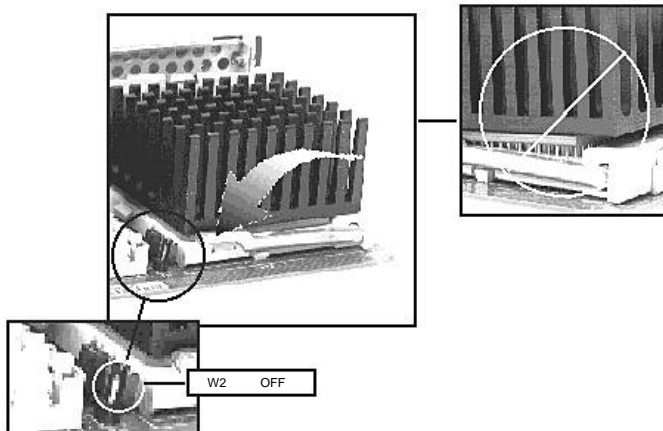

3. Set the W2, W4, W5, and W7 jumpers based on the Intel processor installed. See the System Board Jumpers section (page 103) for settings.

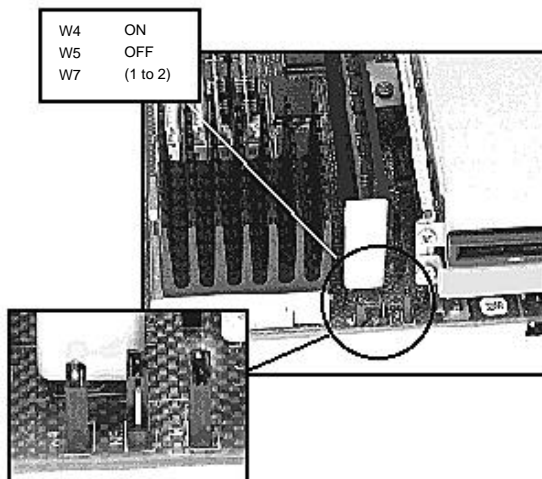

PCI Option

To remove the PCI option

1. Slide out the component drawer.
2. Remove the screw holding the PCI option in place.

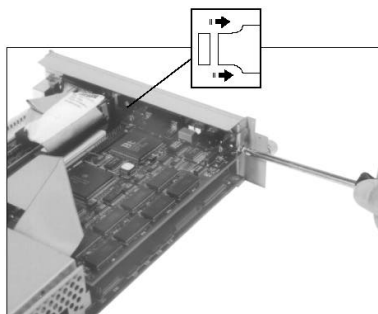

3. Gently slide the PCI option out of its shelf.

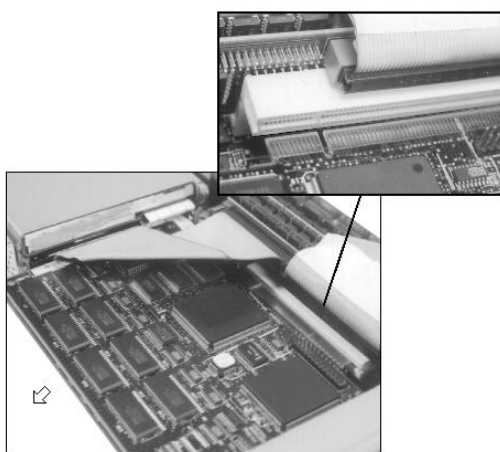

Power Supply

To remove the power supply

1. Slide out the component drawer.
2. Remove the two screws holding the top of the system box in place.

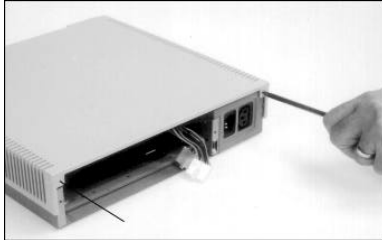

3. Slide the top of the system box to the rear and lift the top off.

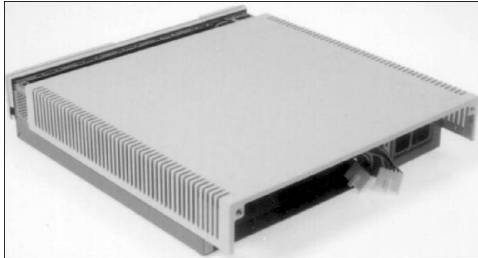

4. Remove the two screws holding the power supply to the system box frame.

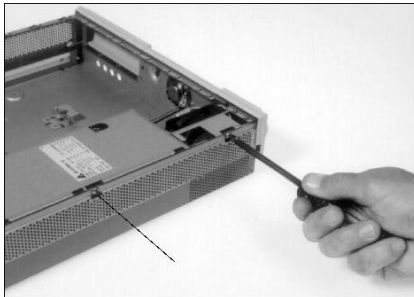

5. Disconnect the in-line connector on the cable for the power switch LED by lifting the connector's tab and pulling the two cable sections apart.

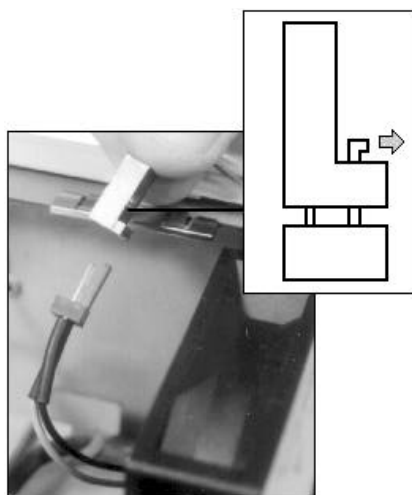

6. Slide the power supply about 0.25 inches toward the center of the system box and carefully route the LED wires behind the fan housing.

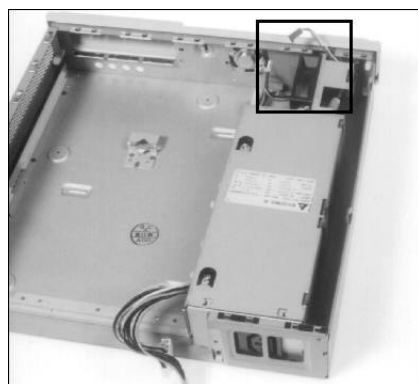

7. Push the rear end of the power switch shaft forward to disconnect it from the power supply shaft.

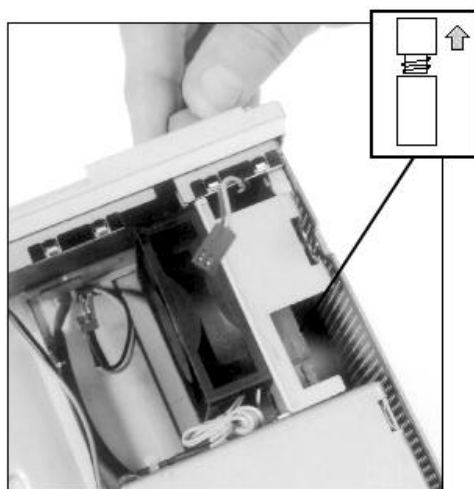

Power Supply

- Use a screwdriver to release the clips holding the front bezel in place, then push the bezel forward about 0.5 inches.

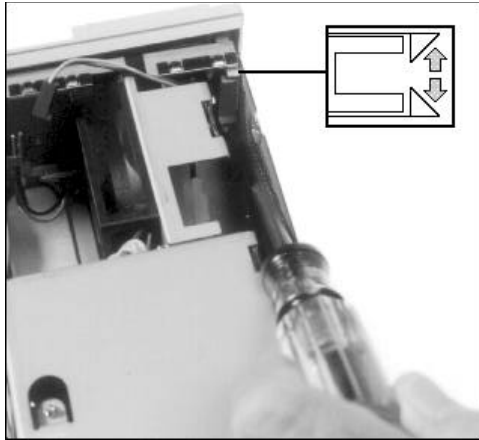

- Disconnect the in-line speaker connector from the power supply.

Some systems have the speaker hardwired to the power supply. In this case, cut the wires about 1.5 inches from the speaker terminals. Splice the wires when you replace the power supply.

Caution

If the speaker is hardwired to the power supply, do not unsolder the wires. Excessive heat can damage the speaker coil.

- Align the fan housing with the L-shaped cutout in the front panel, then lift the power supply assembly out of the system box.

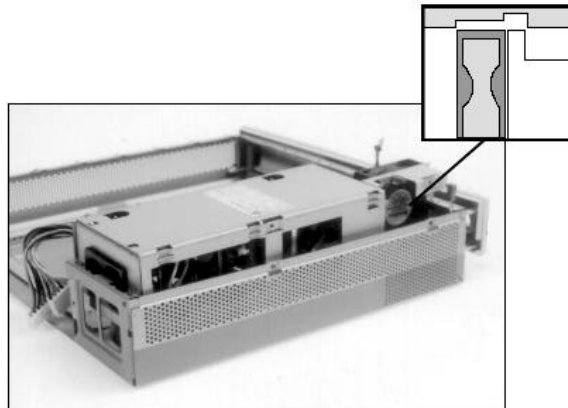

Installation Notes

- When installing the power switch, make sure the LED is on the left (as seen from the front). For models VX41 and VX42, you must use Part Number 70-29128-01, Rev B as a minimum. You can also use this part in model VX40. For VX51 models, you must use part number 70-32437-01.
- Carefully route the LED connector through the cutout near the top corner of the fan housing.

Floppy Disk Drive

To remove the floppy disk drive

1. Slide out the component drawer.
2. Remove the two screws holding the floppy disk drive in place.

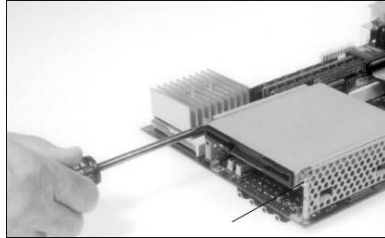

3. Disconnect the ribbon cable from the floppy disk drive.



4. Remove the three screws holding the floppy disk drive in its frame, then slide the drive out of the frame.

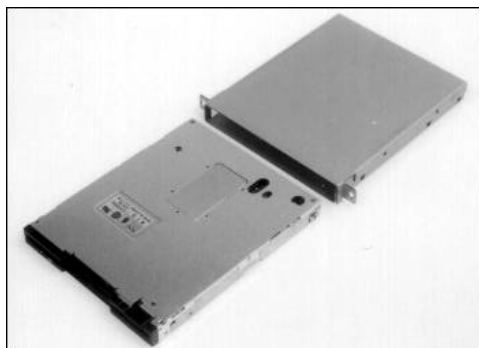
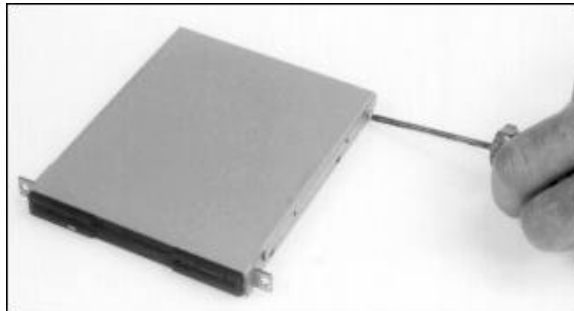

2.5-Inch Hard Disk Drive

To remove the 2.5-inch hard disk drive

1. Slide out the component drawer.
2. Remove the two screws holding the face of the hard disk drive in place.

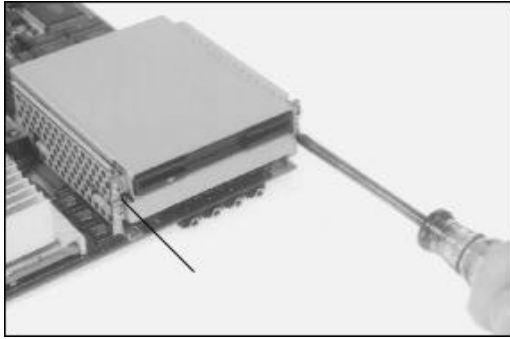

3. **Alpha-based models:** Disconnect the ribbon cable from the rear of the hard disk drive.

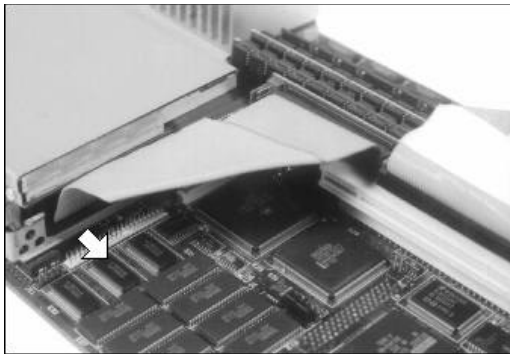

Intel-based models: Disconnect the ribbon cable from the rear of the hard disk drive and from the system board.

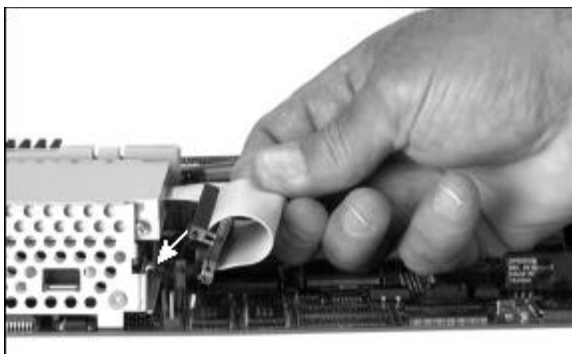

4. Slide the hard disk drive out of the card cage.

An Alpha-based disk drive is shown in the remaining steps.

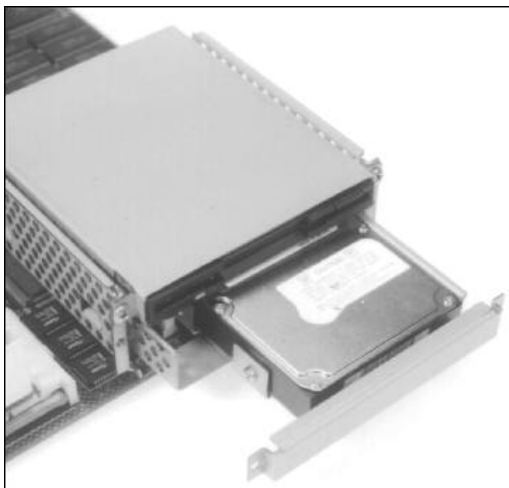

5. Remove the three screws holding the hard disk drive in its frame.

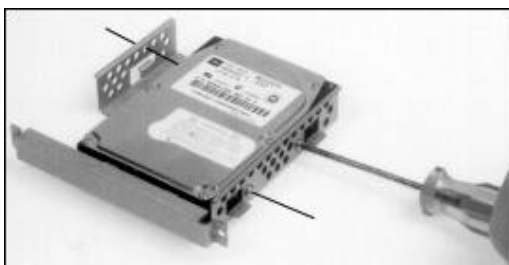

6. Lift the hard disk drive out of its frame.



3.5-Inch Hard Disk Drive (Alpha-Based Models)

3.5-Inch Hard Disk Drive (Alpha-Based Models)

To remove the 3.5-inch hard disk drive

1. Slide out the component drawer.
2. Remove the two screws holding the hard disk drive in place.

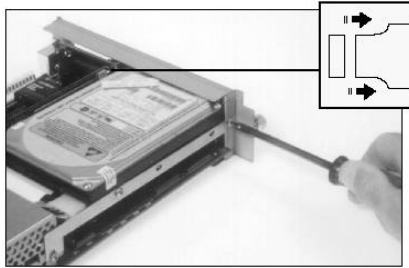

3. Disconnect the 4-wire connector from the backplane.

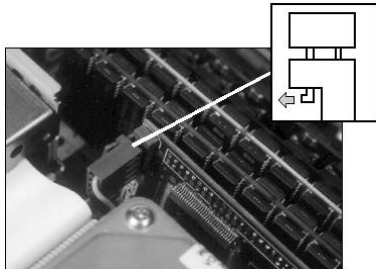

4. Disconnect the ribbon cable from the hard disk drive.

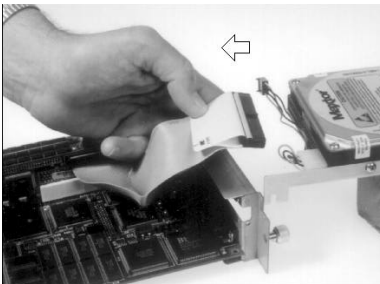

5. Remove the four screws holding the hard disk drive to its frame.
6. Lift the hard disk drive out of its frame.

3.5-Inch Disk Drive (Intel-Based Models)

To remove the 3.5-inch hard disk drive

1. Slide out the component drawer.
2. Remove the two screws holding the hard disk drive in place.

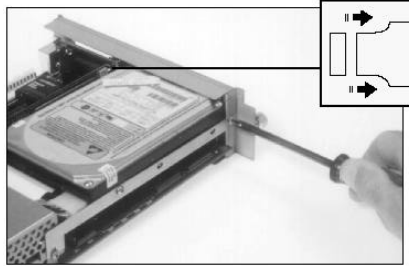

3. Disconnect the drive's 4-wire power connector and ribbon cable from the system board. Then disconnect the ribbon cable from the hard disk drive and lift the drive out.

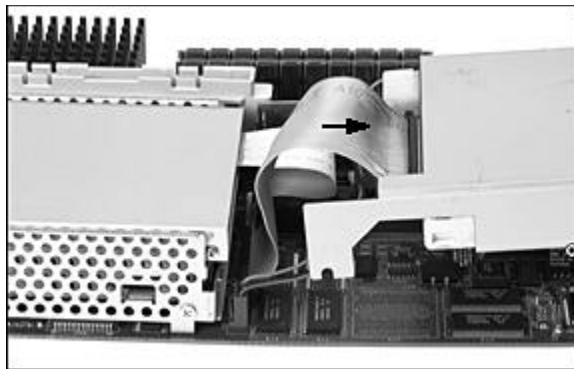

4. Remove the two screws holding the hard disk drive to its frame.
5. Lift the hard disk drive out of its frame.

Backplane

There are two versions of the backplane:

- For desktops with 3.5-inch disk drives (no PCI option connector)
- For desktops with 2.5-inch disk drives (PCI option connector)

To remove the backplane

1. Slide out the component drawer.
2. **For a 3.5-inch hard disk drive**

Remove the drive (page 67), but leave the drive in its frame.

For a 2.5-inch hard disk drive

Disconnect the drive's ribbon cable from the backplane.

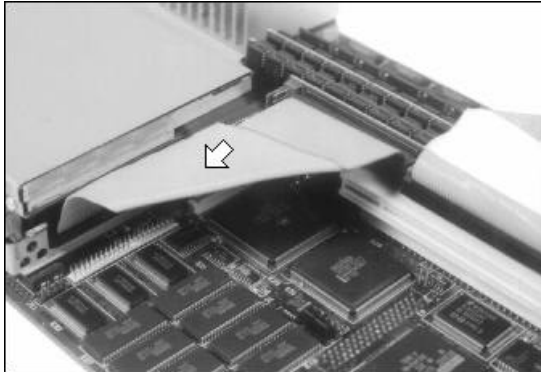

3. If the system has a SCSI-2 cable, disconnect the cable from the backplane.
4. Remove the screw holding the backplane, then disconnect the backplane from its connector.

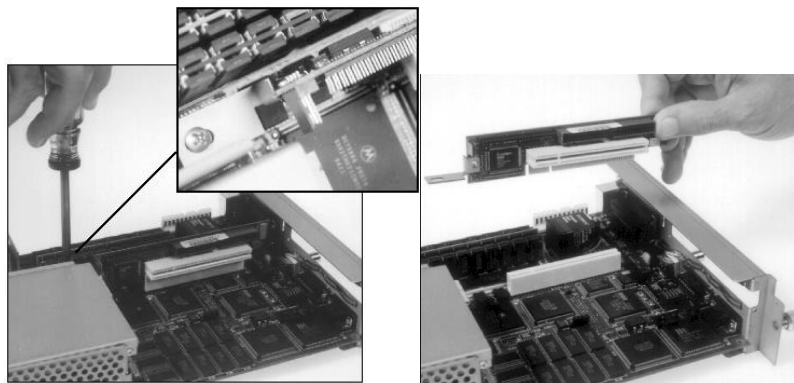

System Board

To remove the system board

1. Slide out the component drawer.
2. Remove all memory modules. See Memory Modules (SIMMs) (page55).
3. Remove the hard disk drive.

For a 3.5-inch hard disk drive

Remove the drive (page 67), but leave the drive in its frame.

For a 2.5-inch hard disk drive

- a. Remove the drive (page 66), but leave the drive in its frame.
- b. Disconnect the ribbon cable from the backplane.

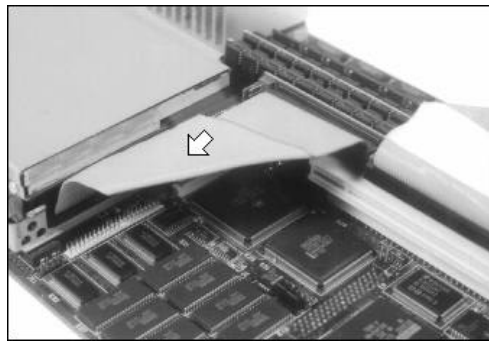

- c. Remove the screw holding the backplane, then disconnect the backplane from its connector.

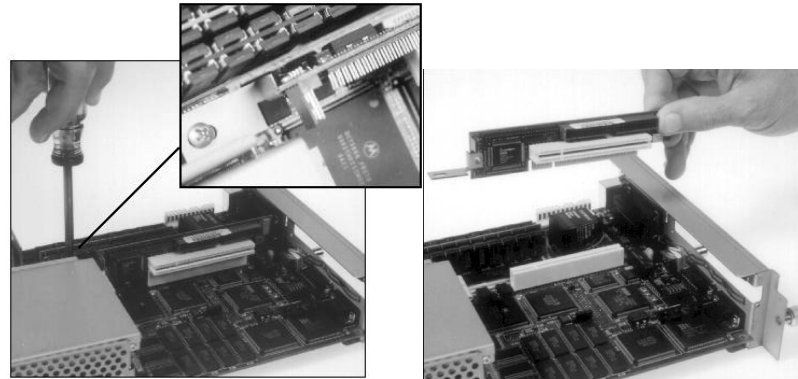

4. Disconnect the floppy drive's ribbon cable from the connector on the system board.

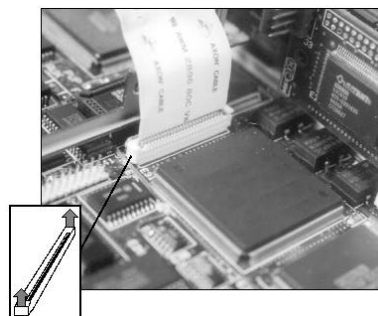

System Board

5. If the system has a SCSI-2 connector, remove the two screws holding the SCSI-2 connector on the rear panel. For model VX40, disconnect the other end of the ribbon cable, then remove the cable (part number 17-04124-01 shown) and connector. Models VX41 and VX42 have an integrated cable.

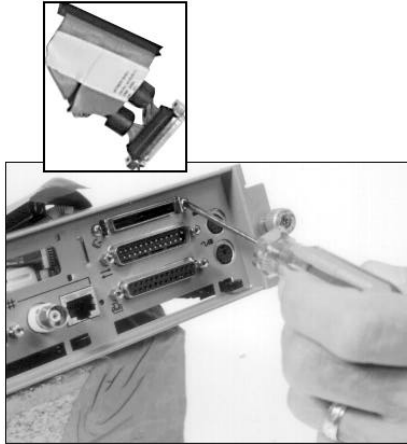

6. Use a chip puller to remove the Ethernet address ROM from its socket between the dc and VRAM chips.

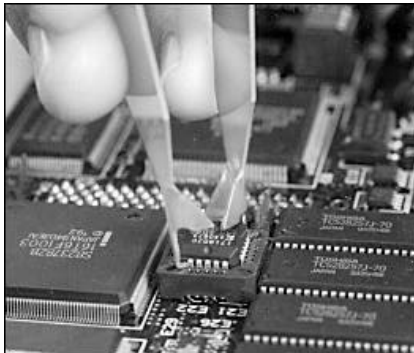

Save the Ethernet address ROM to install on the replacement system board.

Installation Notes

Replace the Ethernet address ROM in its socket, ensuring that the keyway on the chip aligns with the keyway on the socket.

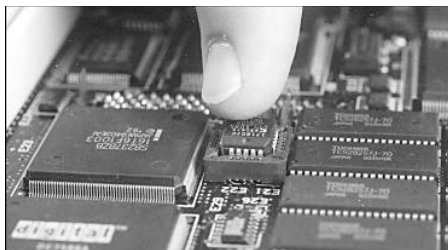

Battery

To remove the battery

1. Slide out the component drawer.
2. **Alpha-based models:** The battery is next to plugs P8 and P9 on the system board. Disconnect the battery connector from the system board. Then rotate the battery upward to remove it from its fabric-lock fastener.

Use battery part number 12-38597-01 or 12-45248-01 for a replacement.

Part number 12-38597-01 shown.

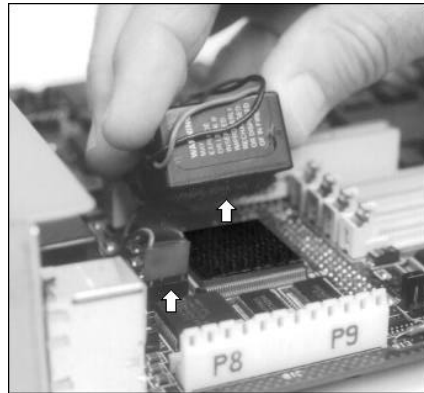

Intel-based models: The battery is on the underside of the system board. Lift the battery out of its seat.

Use battery part number 12-41474-06 for a replacement.

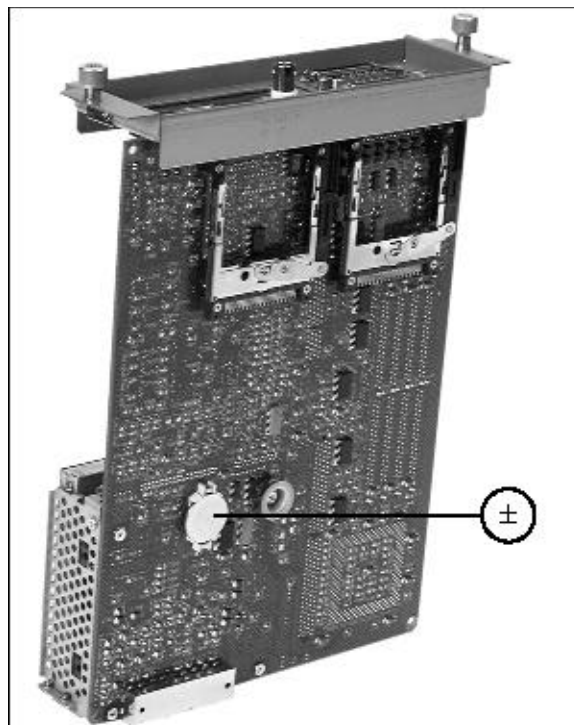

Speaker

To remove the speaker

1. Slide out the component drawer.
2. Remove the two screws holding the top of the system box in place.

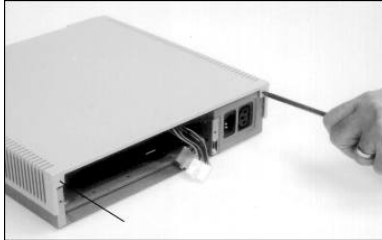

3. Slide the top of the system box to the rear and lift the top off.

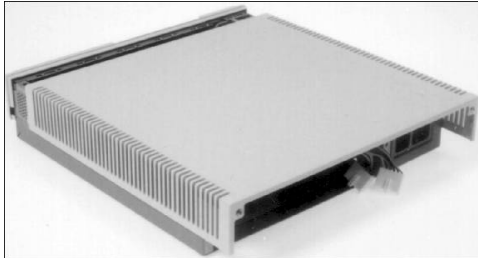

4. Locate the speaker on the front panel and disconnect the speaker connector.

Some systems have the speaker hardwired to the power supply. In this case, cut the wires about 1.5 inches from the speaker terminals. Splice the wires when you replace the power supply.

Caution

If the speaker is hardwired to the power supply, do not unsolder the wires. Excessive heat can damage the speaker coil.



5. Gently slide the speaker over its seating nodule to release the speaker from its tabs.

Floppy Disk Drive Cable

To remove the cable

1. Slide out the component drawer.
2. Access the floppy disk drive cable as follows.

If the system has a 2.5-inch hard disk drive

Disconnect the hard disk drive cable from the backplane.

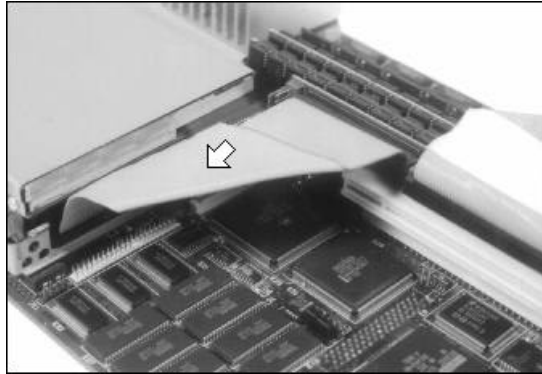

If the system has a 3.5-inch hard disk drive

- a. Remove the two screws holding the hard disk drive in place.

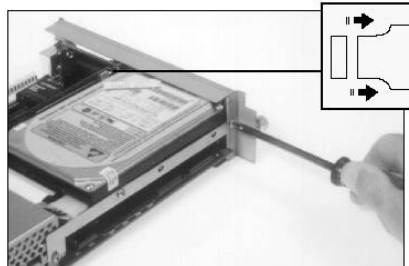

- b. Disconnect the 4-wire connector from the backplane.

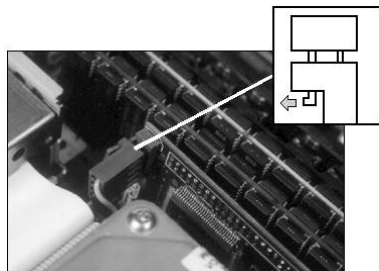

- c. Lift the hard disk drive over the rear panel, out of the way.

Floppy Disk Drive Cable

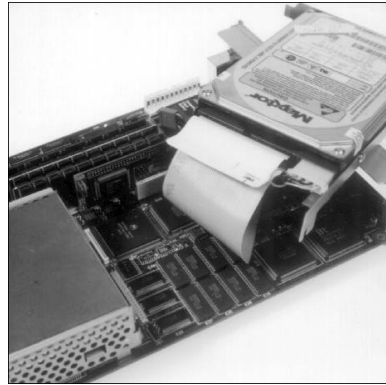

3. Lift the tabs of the floppy disk drive connector on the system board. Then disconnect the ribbon cable.

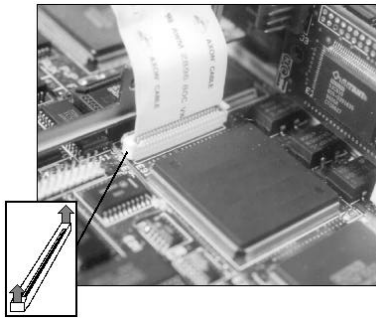

4. Disconnect the ribbon cable from the floppy disk drive.

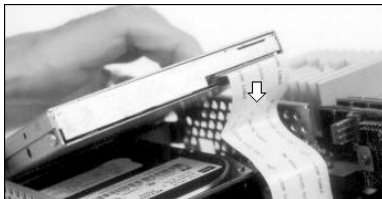

Installation Notes

When reconnecting the ribbon cable to the floppy disk drive, make sure that its 26 metallic fingers face the top of the drive.

When reconnecting the other end of the cable to the system board, make sure the metallic fingers face the rear panel.

After connecting the cable, push down the connector tabs.

Restoring Multia Software

This chapter describes how to restore the software on a Multia desktop to its initial factory state. You need the Multia CD-ROM supplied in the System Administrator Kit. The Multia CD-ROM must be mounted or installed on a system that is network accessible to the desktop you are restoring. For Intel-based models, you also need the RMF diskette supplied in the kit. The chapter covers the following topics:

- Restoring Multia software on a corrupted desktop
- Setting up servers for the Remote Maintenance Facility

Restoring Multia Software on a Corrupted Desktop

The Multia CD-ROM for system administrators lets you restore the software on a Multia desktop to its initial factory state. You perform this procedure from the affected desktop.

The repair procedure first downloads Remote Maintenance Facility (RMF) software provided on the Multia CD-ROM. You must set up MOP or BOOTP and TFTP servers to handle this process.

Caution

When you restore a desktop to its initial factory state, any user files on the local hard disk are lost. If you want to save these files, back them up before performing this procedure.

Refer to the section for your Multia desktop model:

- Intel-based models (page 77)
- Alpha-based models (page 79)

Restoring Intel-Based Models (Multia Version 3.1)

Prerequisites

- **Intel-based models: Multia Version 3.1 CD-ROM and RMF diskette**
Your system administrator's kit provides the CD-ROM and diskette. You need the diskette the first time you restore a desktop.
- **MOP server or BOOTP and TFTP servers**
You can use servers on a host system or Multia-based servers accessible in the Customize Multia window, Services dialog box. Sample `moptab` and `bootptab` files are in `D:\WINNT35\SYSTEM32\DRIVERS\ETC`.

To set up a MOP server or BOOTP and TFTP servers, see page 80.

To restore an Intel-based Multia desktop to its initial software state

Restoring Multia Software on a Corrupted Desktop

1. Mount or install the Multia CD-ROM on an accessible host.
2. Set up the `moptab` file or `bootptab` file.
 - **For a BOOTP server**, specify the correct Multia RMF command file in the `bootptab` file (page 82).

Syntax

```
bf=path\RMFVnnnM.CMD
```

nnn is the Multia version number. For example, if you have mounted the Multia Version 3.1 CD-ROM on your E drive, you would specify

```
bf=E:\V031\files\RMF\RMFV31M.CMD
```
 - **For a Multia MOP server**, simply add the location of the Multia CD-ROM's RMF files to the home directory (HD) in the `moptab` file (page 81).
 - **For an OpenVMS MOP server**, add the location of the Multia CD-ROM's RMF files to the definition of the `MOM$SYSTEM` logical (page 81).
3. **If you use host-based servers**, make sure the servers are running.

If you use Multia servers, start them as follows:

 - a. If the Multia CD-ROM is mounted or installed on a remote network drive, use the Windows NT Control Panel to specify a startup account with administrator privileges for the MOP or TFTP server (page 83).

You can omit this step if the CD-ROM is on a local drive.
 - b. Start the MOP server (page 81) or BOOTP and TFTP servers (page 82) from the Services dialog box of the Customize Multia window.
4. Insert the RMF diskette, then restart the desktop. The RMF software prompts you for
 - Whether or not to partition the disk.

If you answer No, the RMF software overwrites existing files on the disk.

If you answer Yes, the RMF software partitions the disk and installs new files. All existing files on the disk are erased.
 - The network protocol (MOP or BOOTP).
 - The RMF command file name (RMFV31M.CMD for Version 3.1).

When the procedure is complete, the software displays a message telling you to restart the desktop.

When you restart the desktop, it displays the Multia startup screen. At this point, the desktop is in its initial factory state. To restore the desktop's previous configuration, enter the desktop's key.

Performing the RMF Procedure Again

When you perform the first RMF procedure on a desktop, the procedure installs the files from the RMF diskette and adds an RMF menu item to the operating system menu displayed during the power-up sequence. If you need to perform another RMF procedure on that desktop, simply stop the power-up sequence when the menu appears and select the RMF menu item. You do not need the RMF diskette.

Restoring Alpha-Based Models (Multia Version 3.0)

Prerequisites

- **Multia Version 3.0 CD-ROM**
Your system administrator's kit provides the CD-ROM.
- **MOP server or BOOTP and TFTP servers**
You can use servers on a host system or Multia-based servers accessible in the Customize Multia window, Services dialog box. Sample `moptab` and `bootptab` files are in `D:\WINNT35\SYSTEM32\DRIVERS\ETC`.

To set up a MOP server or BOOTP and TFTP servers, see page 80.

To restore a Multia desktop to its initial software state

Check the type of network connection on the rear of the system box before you start: ThinWire, thickwire, or twisted pair.

1. Mount or install the Multia CD-ROM on an accessible host.
2. Set up the `moptab` file or `bootptab` file.
 - **For a BOOTP server**, specify the correct Multia boot file in the `bootptab` file (page 82), based on your type of network connection:

ThinWire or twisted pair	<code>bf=path\RMF.SYS</code>
Thickwire	<code>bf=path\RMFAUL.SYS</code>
 - **For a Multia MOP server**, simply add the location of the Multia CD-ROM's RMF files to the home directory (HD) in the `moptab` file (page 81).
 - **For an OpenVMS MOP server**, add the location of the Multia CD-ROM's RMF files to the definition of the `MOM$SYSTEM` logical (page 81).
3. **If you use Multia servers**, start them as follows:
 - a. If the Multia CD-ROM is mounted or installed on a remote network drive, use the Windows NT Control Panel to specify a startup account with administrator privileges for the MOP or TFTP server (page 83).
You can omit this step if the CD-ROM is on a local drive.
 - b. Start the MOP server (page 81) or BOOTP and TFTP servers (page 82) from the Services dialog box of the Customize Multia window.
4. Restart the desktop that has the corrupted disk.
5. When the Boot menu appears on the blue screen, press an arrow key to halt the display.
6. In the Boot menu, choose Supplementary menu.
7. In the Supplementary menu, choose Set up the system.
8. In the Setup menu, choose Switch to OpenVMS or OSF console.
9. In the next screen, choose Switch to OSF.
10. Choose Setup menu, then turn the power button on the system box off and on.
The desktop displays a `>>>>` prompt.
11. At the `>>>>` prompt, enter the following commands:

```
>>> set auto_action halt
>>> set boot_osflags N
```
12. Enter a boot command based on your server and network connector:

Setting Up Servers for the Remote Maintenance Facility

- **MOP server, ThinWire or twisted-pair network**

```
>>> b -p MOP -file RMFM.SYS ew
```
- **MOP server, thickwire network**

```
>>> b -p MOP -file RMFMAUI.SYS ew
```
- **BOOTP server, ThinWire, twisted-pair, or thickwire network**

```
>>> b -p BOOTP ew
```

Wait for the host to download the file to the desktop. If an error occurs, check that your MOP server or BOOTP and TFTP servers are set up correctly and point to the location of the RMF files from the CD-ROM.

13. On some models, the desktop will autostart.

On other models, the >>> prompt appears again. If the prompt appears, enter Arc and press Return.

```
>>> Arc
```

The desktop restarts and displays the Multia startup screen. At this point, the desktop is in its initial factory state. To restore the desktop's previous configuration, enter the desktop's key.

Setting Up Servers for the Remote Maintenance Facility

The Multia CD-ROM includes a Remote Maintenance Facility (RMF) that is invoked when you

- Perform a Multia software update that includes the operating system
- Perform a Multia firmware update
- Restore Multia software to a corrupted desktop

When you select a software or firmware update from the Configuration Manager, the Confirm Software Update dialog box indicates whether or not the update requires the RMF software.

The automated update or repair procedure first downloads the RMF software from the CD-ROM kit to the selected desktop. Then the RMF software initializes the desktop's disk and downloads the Multia software from the CD-ROM kit to the desktop.

To download the RMF software, you need

- A maintenance operations protocol (MOP) server, or
- A boot protocol (BOOTP) server and trivial file transfer protocol (TFTP) server

You can use the servers provided with each desktop or the servers on a host system.

Using the MOP server provided with the desktop can reduce administrative overhead, because you do not have to maintain a list of client desktops in the `moptab` file. Since desktops include built-in support for MOP communication, you can use this approach even in environments that typically use BOOTP and TFTP servers.

Caution

When you perform major updates involving the operating system, the desktop is restored to an initial state. Any user files or additional software files installed on the desktop's hard disk will be lost. If you want to save these files, back them up before performing major updates.

Using Multia Servers

To start Multia servers, you use the Services dialog box in the Customize Multia window. When you start a MOP or BOOTP server, you specify the network path to the `moptab` or `bootptab` configuration file. For details, see the online help in the Services dialog box.

Configuring a Multia MOP Server

If you plan to use a Multia MOP server for updates and repairs, you must set up the `moptab` configuration file. Each desktop comes with a sample `moptab` file in the following location:

```
D:\WINNT35\SYSTEM32\DRIVERS\ETC\MOPTAB
```

The `moptab` file must specify the network path to the home directory (HD) or directories containing the Multia RMF files to serve for the update or repair. The network path is the only required information.

The MOP server will service requests from any MOP client for Multia software. The client request includes a software identification (SI) for the file it is requesting. The MOP server checks the home directory list for the requested file.

Moptab Syntax

The `moptab` file for a Multia MOP server uses the following syntax:

HD=directory1; . . . ;directoryn

HD specifies one or more directories to search for the requested RMF files. The Multia CD-ROM provides the RMF files in an `\RMF` subdirectory (Version 3.1 and later) or `\EDR` subdirectory (Version 3.0). Separate directories with a semicolon. For example:

```
HD=D:\MULTIA\EDR;F:\KITS\EDR
```

As an option, you can specify individual clients in the `moptab` file, along with the file (SI) to serve each client. This allows the MOP server to serve requests from those clients even when the request does not specify a file. For details, see the explanation in the sample `moptab` file provided with the desktop.

The `moptab` file must reside in the following location:

```
D:\WINNT35\SYSTEM32\DRIVERS\ETC\MOPTAB
```

Configuring an OpenVMS MOP Server

If you use a MOP server on an OpenVMS host system, add the location of the Multia CD-ROM's RMF files to the definition of the `MOM$SYSTEM` logical. Use the `DCL DEFINE` command from an account that has system privileges. For example:

```
$ SHOW LOGICAL MOM$SYSTEM
  "MOM$SYSTEM" = "SYS$SYSROOT:[MOM$SYSTEM]" (LNM$SYSTEM_TABLE)
$ DEFINE MOM$SYSTEM SYS$SYSROOT:[MOM$SYSTEM], RMF_directory
```

RMF_directory is the location of the RMF files. For example, if you installed the RMF files in `SYS$SYSROOT:[MOM$SYSTEM.RMF]`, you would enter

```
$ DEFINE MOM$SYSTEM SYS$SYSROOT:[MOM$SYSTEM], -_
_ $ SYS$SYSROOT:[MOM$SYSTEM.RMF]
```

Starting the Multia MOP Server

If you want to use the Multia MOP server, start the server from the Customize Multia window.

1. In the Customize Multia window, click the services icon.
2. In the Services box, select the MOP server.
3. Enter and save the startup parameters. You have the option to specify the path to the `moptab` file. By default, the MOP server uses the following file:

```
D:\WINNT35\SYSTEM32\DRIVERS\ETC\MOPTAB
```

4. Choose Start and Automatic to start the server now and have it automatically start whenever the desktop is restarted.

Setting Up Servers for the Remote Maintenance Facility

For More Information

See the online help in the Services dialog box.

Configuring a BOOTP Server

If you plan to use a BOOTP server and TFTP server for updates and repairs, you must set up the `bootptab` configuration file. Each desktop comes with a sample `bootptab` file in the following location:

```
D:\WINNT35\SYSTEM32\DRIVERS\ETC\BOOTPTAB
```

The `bootptab` file must contain an entry for each Multia desktop client to be serviced by the BOOTP server.

Bootptab Syntax

For each Multia desktop, add the following entry in the `bootptab` file. Use a colon to separate parameters.

Desktop: ht=1: ha=*hardware address*: ip= *IP address*: bf=*RMF command file*

Desktop

Specifies the desktop's name.

ht=1

Specifies the desktop's hardware type. This value is always 1 or ethernet.

ha=*hardware address*

Specifies the desktop's Ethernet hardware address. You must specify the address in hexadecimal numbers. You can include optional periods and a leading 0x for readability.

ip=*IP address*

Specifies the desktop's IP address. Use standard Internet dot notation, decimal, octal, or hexadecimal numbers. Octal numbers begin with 0, hexadecimal numbers begin with 0x or 0X.

bf=*RMF image file*

Specifies the path to an RMF boot file in the Multia CD-ROM kit. The Multia CD-ROM provides the RMF files in an \RMF subdirectory (Version 3.1 and later) or \EDR subdirectory (Version 3.0)

- For Intel-based models

The RMF boot file is `RMFVnnnM.CMD`, where `nnn` is the Multia version. For Multia Version 3.1, the file is `RMFV31M.CMD`

- For Alpha-based models

Specify an RMF boot file based on the type of network connection used by your desktops:

ThinWire or twisted-pair	RMF.SYS
Thickwire	RMFAUL.SYS

Sample bootptab File Entries

```
fiery: ht=ethernet: ha=08002b253673: ip=16.34.176.93:\
      hd="d:": bf="\winnt\system32\drivers\etc\RMF.SYS":
```

Starting the Multia BOOTP Server

If you want to use the Multia BOOTP server, start the server from the Customize Multia window. You also must start the TFTP server.

1. In the Customize Multia window, click the services icon.
2. In the Services box, select the BOOTP server.
3. Enter and save the BOOTP startup parameters. You have the option to specify the path to the `bootptab` file. By default, the BOOTP server uses the following file:

```
D:\WINNT35\SYSTEM32\DRIVERS\ETC\BOOTPTAB
```

4. Choose Start and Automatic to start the server now and have it automatically start whenever the desktop is restarted.
5. Repeat steps 2 to 4 for the TFTP server.

In the TFTP startup parameters, you can include a restricted path to search for file requests.

See the online help in the Services dialog box.

**For More
Information**

Specifying a Multia MOP or TFTP Startup Account

If the Multia CD-ROM is mounted or installed on a remote network drive, you must specify a startup account for the Multia MOP or TFTP server before performing repairs or upgrades with those servers. Create this account on the administrative desktop that will run the servers.

You cannot create a startup account if you have installed the Multia X Server option. In this case, you must start the Multia servers from a command window.

To specify a startup account for the Multia MOP or TFTP server

1. If the selected server is currently running, stop the server in the Services dialog box of the Customize Multia window.
2. Press Ctrl + Esc to display the Windows NT Task List.
3. In the New Task box, enter Control Services and choose Run.
4. In the Services dialog box, select the Multia MOP Server or Multia TFTP Server.
5. Choose Startup.
6. In the Log On As area, select This Account and specify an account on this desktop that has administrator privileges.
7. Choose OK.
8. Choose Close.

After creating the account, you can start the selected server in the Services dialog box of the Customize Multia window.

**Multia X
Server
Installed?**

If the Multia CD-ROM is on a remote drive and you have installed the Multia X Server, you can start the Multia servers only from a command window. The NFS services supplied with the Multia X Server prevent the startup account from working. In this case, starting any service from a startup account will hang the desktop in use.

Setting Up Servers for the Remote Maintenance Facility

To start the Multia MOP, BOOTP, or TFTP servers from a command window

1. Press Ctrl + Esc to display the Windows NT Task List.
2. In the New Task box, enter CMD and choose Run.

The desktop displays a cmd window with a command prompt indicating the current default directory. For example:

```
\users\qsusers>
```

3. Use the following command syntax to start the desired server.
[] brackets indicate optional parameters.

- **BOOTP server**

bootpsrv [-d] [*bootptab_file*]

-d is the debug flag.

If you do not specify a bootptab file, the desktop uses the default bootptab file path
%SystemRoot%\SYSTEM32\DRIVERS\ETC\bootptab.

- **TFTP server**

tftpsrv [-d] [-r *restricted_path*]

-d is the debug flag.

If you do not specify a restricted path, then the TFTP server uses the default restricted path defined by %HOMEPATH%.

- **MOP server**

mopd [-d] [*moptab_file*]

-d is the debug flag.

If you do not specify a moptab file, the desktop uses the default moptab file path
%SystemRoot%\SYSTEM32\DRIVERS\ETC\moptab.

A

Part Numbers

Recommended Spares List

Field Replaceable Units

Description	Part Number	Used On			
		VX40	VX41	VX42	VX51
Alpha-based system board assembly (integrated CPU chip)	70-29110-01	X			
Alpha-based system board assembly (no CPU chip)	70-32588-03		X	X	
233 MHz Alpha CPU	VX41Z-AA			X	
166 MHz Alpha CPU	VX41Z-AB		X		
Intel-based system board assembly (no CPU chip)	70-32589-01				X
100 MHz Pentium CPU and heatsink	70-31905-09				X
Backplane (internal SCSI bus)	54-22563-01	X			
Backplane (PCI slot, internal/external SCSI bus)	54-22563-02	X	X	X	X
Backplane (PCI slot, external SCSI bus)	54-22563-03		X	X	X
Power supply assembly with speaker	70-29128-01A	X			X
	70-29128-01B	X	X	X	X
Battery	12-38597-01	X	X	X	
	12-45248-01	X	X	X	
3 V Lithium	12-41474-06				X

Recommended Spares List

General Recommended Spares

Description	Part Number	Used On				Unique
		VX40	VX41	VX42	VX51	
340 MB 2.5-inch SCSI disk drive, no software	00-0RZ14-E	X				Y
	00-0RZ15-E	1	X	X		Y
340 MB 3.5-inch SCSI disk drive, no software (Can be replaced with either of the 540 MB 3.5-inch SCSI disk drives)	00-RZ24M-E0	X				N
540 MB 3.5-inch SCSI disk drive, no software	00-RZ25F-E0	2	X	X		N
	00-RZ25Q-E0	3	X	X		N
1 GB disk drive (for EasyWeb server system)	00-RZ26F-E0	X		X		N
810 MB 2.5-inch hard disk drive	00-0RE18-E0				X	Y
1 GB 3.5-inch hard disk drive	00-RE26F-E0				X	N
Floppy disk drive (3.5 inch, Citizen WIDA)	00-0RX10-AA	X	X	X	X	Y
Front bracket assembly	70-29111-01	X	X	X		N
Front bezel (includes door)	70-32436-01				X	Y
Top cover assembly (includes top shield)	70-31623-03	X	X	X	X	N
Chassis	70-29113-01	X	X	X		N
Stand assembly	70-31616-01	X	X	X	X	N
Wire, bail	74-48263-01	X	X	X	X	N
Mouse, DEC PS/2	30-41053-01	X	X	X	X	N
Mouse pad	12-36561-01	X	X	X	X	N
Bracket, ISA slot	74-48303-01	X	X	X	X	N
Bracket disk, blank	74-49232-01	X	X	X	X	Y
Screw 6-32 .187	90-11334-01	X	X	X	X	N
Power button assembly	70-31647-01	X	X	X		N
	70-32437-01				X	Y
Speaker with connector	12-43508-01	X	X	X	X	Y
3.5-inch floppy drive cable	17-03600-01	X	X	X	X	N
4 MB 70 ns DRAM ⁴	ME524-DE	X	X	X		N
8 MB 70 ns DRAM ⁴	ME534-DE	X	X	X		N

¹ Can be used on an VX40*-*2 system.

² Can be used on any VX40*-*3 system.

³ Can be used on any VX40*-*3 system.

⁴ One SIMM. To order SIMMS in pairs, see Memory Modules (page 91).

Description	Part Number	Used On				Unique
16 MB 70 ns DRAM ⁴	54-21277-CA	X	X	X		N
32 MB 70 ns DRAM ⁴	ME654-DE	X	X	X		N
8 MB 70 ns DRAM	54-21246-EA				X	N
12 MB SIMM	54-23627-AA		X	X		N
256 KB Cache SIMM	VX41M-AA		X	X		N
512 KB Cache SIMM	VX41M-AB		X	X		N
1 MB Cache SIMM	VX41M-AC		X	X		N
256 KB Cache SIMM (asynchronous)	20-46316-01				X	N
	54-24072-01				X	N

Hardware

Part Numbering Conventions

V	X	*	*	*	-	*	*	Explanation
		4						Multia Alpha CPU (166 or 233 MHz)
		5						Multia Intel CPU (100, 120, or 133 MHz)
			0					Multia with fixed 256K cache and fixed 166 MHz Alpha CPU
			1					Multia with flexible 256K cache, ZIF socket, 100 or 166 MHz CPU
			2					Multia with flexible 512K cache, ZIF socket, 233 MHz CPU
				A				Multia system shipped with power cord
				B				Multia system shipped without power cord
				D				Multia system, domestic (USA) built
				E				Web server system box
				J				Multia system for Japan
				M				Multia option for DRAM
				N				Multia option floppy upgrade kit
				R				Multia option hard disk upgrade kit
				Z				Multia option CPU upgrade kit
						C		Seed unit build
						F		3.5-inch floppy installed
						N		No floppy
						V		COMDEX unit build
							2	2.5-inch disk with PCI slot and external SCSI
							3	3.5-inch disk without PCI slot No external SCSI included on VX40 models External SCSI on VX41 and VX42 models

Multia Single System Box

VX40 Models

Part Number	Description
VX40A-F2	System box with fixed 256K cache, fixed 166 MHz Alpha CPU, 24 MB, 2.5-inch 340 MB disk, 3.5-inch floppy, PCI slot, external SCSI disk drive, U.S. power cord
VX40A-N2	System box with fixed 256K cache, fixed 166 MHz Alpha CPU, 24 MB, 2.5-inch 340 MB disk, PCI slot, external SCSI disk drive, U.S. power cord (No floppy)
VX40A-F3	System box with fixed 256K cache, fixed 166 MHz Alpha CPU, 24 MB, 3.5-inch 340 MB disk, 3.5-inch floppy, U.S. power cord (No PCI slot or external SCSI disk drive)
VX40A-N3	System box with fixed 256K cache, fixed 166 MHz Alpha CPU, 24 MB, 3.5-inch 340 MB disk, U.S. power cord (No floppy, PCI slot, or external SCSI disk drive)
VX40B-F2	System box with fixed 256K cache, fixed 166 MHz Alpha CPU, 24 MB, 2.5-inch 340 MB disk, 3.5-inch floppy, PCI slot, external SCSI disk drive (No power cord)
VX40B-N2	System box with fixed 256K cache, fixed 166 MHz Alpha CPU, 24 MB, 2.5-inch 340 MB disk, PCI slot, external SCSI disk drive (No floppy or power cord)
VX40B-F3	System box with fixed 256K cache, fixed 166 MHz Alpha CPU, 24 MB, 3.5-inch 340 MB disk, 3.5-inch floppy (No PCI slot, external SCSI disk drive, or power cord)
VX40B-N3	System box with fixed 256K cache, fixed 166 MHz Alpha CPU, 24 MB, 3.5-inch 340 MB disk (No floppy, PCI slot, external SCSI disk drive, or power cord)
VX40B-C2	System box with fixed 256K cache, fixed 166 MHz Alpha CPU, 32 MB, 2.5-inch 340 MB disk, 3.5-inch floppy, PCI slot, external SCSI disk drive, Seed unit build, FCC verified (No power cord)
VX40B-V2	System box with fixed 256K cache, fixed 166 MHz Alpha CPU, 32 MB, 2.5-inch 340 MB disk, 3.5-inch floppy, PCI slot, external SCSI disk drive, COMDEX unit build, FCC verified (No power cord)
VX40B-FD	Denmark (VX40B-F2 + BN19K-2E power cord)
VX40B-FE	UK (VX40B-F2 + BN19A-2E power cord)
VX40B-FK	Switzerland (VX40B-F2 + BN19E-2E power cord)
VX40B-FT	Israel (VX40B-F2 + BN18L-2E power cord)
VX40B-FX	Europe (VX40B-F2 + BN19C-2E power cord)
VX40B-FZ	Southern Hemisphere (VX40B-F2 + BN19H-2E power cord)
VX40D-F2	System box with fixed 256K cache, fixed 166 MHz Alpha CPU, 24 MB, 2.5-inch 340 MB disk, 3.5-inch floppy, PCI slot, external SCSI disk drive, USA build (No power cord)
VX40D-N2	System box with fixed 256K cache, fixed 166 MHz Alpha CPU, 24 MB, 2.5-inch 340 MB disk, PCI slot, external SCSI disk drive, USA build (No floppy or power cord)

Part Number	Description
VX40D-F3	System box with fixed 256K cache, fixed 166 MHz Alpha CPU, 24 MB, 3.5-inch 340 MB disk, 3.5-inch floppy, USA build (No PCI slot, external SCSI disk drive, or power cord)
VX40D-N3	System box with fixed 256K cache, fixed 166 MHz Alpha CPU, 24 MB, 3.5-inch 340 MB disk, USA build (No floppy, PCI slot, external SCSI disk drive, or power cord)
VX40E-F3	Web server system box, 166 MHz Alpha CPU, 32 MB, 3.5-inch floppy, 3.5-inch 1 GB disk, power cord
VX40J-F2	System box with fixed 256K cache, fixed 166 MHz Alpha CPU, 16 MB, 2.5-inch 340 MB disk, 3.5-inch floppy, PCI slot, external SCSI disk drive, U.S. power cord, for Japan

VX41 Models

Part Number	Description
VX41A-F2	System box with flexible 256K cache, ZIF socket 166 MHz Alpha CPU, 24 MB, 2.5-inch 528 MB disk, 3.5-inch floppy, PCI slot, external SCSI disk drive, U.S. power cord
VX41A-F3	System box with flexible 256K cache, ZIF socket 166 MHz Alpha CPU, 24 MB, 3.5-inch 540 MB disk, 3.5-inch floppy, external SCSI disk drive, U.S. power cord (No PCI slot)
VX41B-F2	System box with flexible 256K cache, ZIF socket 166 MHz Alpha CPU, 24 MB, 2.5-inch 528 MB disk, 3.5-inch floppy, PCI slot, external SCSI disk drive (No power cord)
VX41B-F3	System box with flexible 256K cache, ZIF socket 166 MHz Alpha CPU, 24 MB, 3.5-inch 540 MB disk, 3.5-inch floppy, external SCSI disk drive (No PCI slot or power cord)
VX41B-FD	Denmark (VX41B-F2 + BN19K-2E power cord)
VX41B-FE	UK (VX41B-F2 + BN19A-2E power cord)
VX41B-FK	Switzerland (VX41B-F2 + BN19E-2E power cord)
VX41B-FT	Israel (VX41B-F2 + BN18L-2E power cord)
VX41B-FX	Europe (VX41B-F2 + BN19C-2E power cord)
VX41B-FZ	Southern Hemisphere (VX41B-F2 + BN19H-2E power cord)
VX41D-F2	System box with flexible 256K cache, ZIF socket 233 MHz Alpha CPU, 24 MB, 2.5-inch 528 MB disk, 3.5-inch floppy, PCI slot, external SCSI disk drive, U.S. power cord, US build
VX41D-F3	System box with flexible 256K cache, ZIF socket 233 MHz Alpha CPU, 24 MB, 3.5-inch 540 MB disk, 3.5-inch floppy, external SCSI disk drive, U.S. power cord, U.S. build (No PCI slot)
VX41J-F2	System box with flexible 256K cache, ZIF socket 233 MHz Alpha CPU, 16 MB, 2.5-inch 528 MB disk, 3.5-inch floppy, PCI slot, external SCSI disk drive, U.S. power cord, for Japan

VX42 Models

Part Number	Description
VX42A-F2	System box with flexible 512K cache, ZIF socket 233 MHz Alpha CPU, 24 MB, 2.5-inch 528 MB disk, 3.5-inch floppy, PCI slot, external SCSI disk drive, U.S. power cord
VX42A-F3	System box with flexible 512K cache, ZIF socket 233 MHz Alpha CPU, 24 MB, 3.5-inch 540 MB disk, 3.5-inch floppy, external SCSI disk drive, U.S. power cord (No PCI slot)
VX42B-F2	System box with flexible 512K cache, ZIF socket 233 MHz Alpha CPU, 24 MB, 2.5-inch 528 MB disk, 3.5-inch floppy, PCI slot, external SCSI disk drive (No power cord)
VX42B-F3	System box with flexible 512K cache, ZIF socket 233 MHz Alpha CPU, 24 MB, 3.5-inch 540 MB disk, 3.5-inch floppy, external SCSI disk drive (No power cord or PCI slot)
VX42B-FD	Denmark (VX42B-F2 + BN19K-2E power cord)
VX42B-FE	UK (VX42B-F2 + BN19A-2E power cord)
VX42B-FK	Switzerland (VX42B-F2 + BN19E-2E power cord)
VX42B-FT	Israel (VX42B-F2 + BN18L-2E power cord)
VX42B-FX	Europe (VX42B-F2 + BN19C-2E power cord)
VX42B-FZ	Southern Hemisphere (VX42B-F2 + BN19H-2E power cord)
VX42D-F2	System box with flexible 512K cache, ZIF socket 233 MHz Alpha CPU, 24 MB, 2.5-inch 528 MB disk, 3.5-inch floppy, PCI slot, external SCSI disk drive, U.S. power cord, U.S. build
VX42D-F3	System box with flexible 512K cache, ZIF socket 233 MHz Alpha CPU, 24 MB, 3.5-inch 540 MB disk, 3.5-inch floppy, external SCSI disk drive, U.S. power cord, U.S. build (No PCI slot)
VX42E-F3	Web server system box, 233 MHz Alpha CPU, 32 MB, 3.5-inch floppy, 3.5-inch 1 GB disk, power cord
VX42J-F2	System box with flexible 512K cache, ZIF socket 233 MHz Alpha CPU, 16 MB, 2.5-inch 528 MB disk, 3.5-inch floppy, PCI slot, external SCSI disk drive, U.S. power cord, for Japan

VX51 Models

Part Number	Description
VX51A-F2	System box with flexible 512K cache, ZIF socket 100 MHz Intel CPU, 16 MB, 2.5-inch or 3.5-inch 810 MB or 1GB disk, 3.5-inch floppy, with PCI slot, external SCSI disk drive, U.S. power cord
VX51A-F3	System box with flexible 512K cache, ZIF socket 100 MHz Intel CPU, 16 MB, 2.5-inch or 3.5-inch 810 MB or 1GB disk, 3.5-inch floppy, external SCSI disk drive, U.S. power cord

Part Number	Description
	(No PCI slot)
VX51B-F2	System box with flexible 512K cache, ZIF socket 100 MHz Intel CPU, 16 MB, 2.5-inch or 3.5-inch 810 MB or 1GB disk, 3.5-inch floppy, with PCI slot, external SCSI disk drive (No power cord)
VX51B-F3	System box with flexible 512K cache, ZIF socket 100 MHz Intel CPU, 16 MB, 2.5-inch or 3.5-inch 810 MB or 1GB disk, 3.5-inch floppy, external SCSI disk drive (No power cord or PCI slot)
VX51B-FD	Denmark (VX51B-F2 + BN19K-2E power cord)
VX51B-FE	UK (VX51B-F2 + BN19A-2E power cord)
VX51B-FK	Switzerland (VX51B-F2 + BN19E-2E power cord)
VX51B-FT	Israel (VX51B-F2 + BN18L-2E power cord)
VX51B-FX	Europe (VX51B-F2 + BN19C-2E power cord)
VX51B-FZ	Southern Hemisphere (VX51B-F2 + BN19H-2E power cord)

Memory Modules

Size	SIMMs Provided	For Models	Part Number
8 MB	Two 4 MB SIMMs	All	VX40M-AA
16 MB	Two 8 MB SIMMs	All	VX40M-AB
12 MB	One 12 MB SIMMs	VX41, VX42	54-23627-AA
32 MB	Two 16 MB SIMMs	All	VX40M-AC
64 MB	Two 32 MB SIMMs	All	VX40M-AD
256K cache SIMM	One 256K Cache SIMM	VX41	VX41M-AA
512K cache SIMM	One 512K Cache SIMM	VX41	VX41M-AB
1 MB cache SIMM	One 1 MB Cache SIMM	VX41	VX41M-AC

VX51 models can any use 256K or 512K asynchronous, burst, or pipelined burst cache memory that complies with the Intel COAST (Cache on a Stick) Version 1.1 specification . The specification is for Pentium-based models that use the Intel 92430FX Triton PCI set.

Disk Drives

Description	Part Number
Floppy disk drive option	VX40N-AA
Hard disk drive option (340 MB, 2.5-inch, SCSI-2)	VX40R-A2
Hard disk drive option (528 MB, 2.5-inch, SCSI-2)	VX40R-B2
Hard disk drive option (1 GB)	VX40R-C2

Keyboards

Country	Standard VT style (108 keys)	WPS style (108 keys)	PC style (101/102 keys)
US	LK411-AA	LK412-AA	PCXAL-GA
UK	LK411-AA	LK412-AA	PCXAL-GE
Belgium Flemish	LK411-AB	LK412-AB	PCXAL-GB
Canadian/French	LK411-AC	LK412-AC	PCXAL-GC
Danish	LK411-AD	LK412-AD	PCXAL-GD
Finnish	LK411-AF	LK412-AF	PCXAL-JA
German	LK411-AG	LK412-AG	PCXAL-GG
Dutch	LK411-AH	LK412-AH	PCXAL-GH
Italian	LK411-AI	LK412-AI	PCXAL-GI
Swiss/French	LK411-AK	LK412-AK	PCXAL-GK
Swiss/German	LK411-AL	LK412-AL	PCXAL-GL
Swedish	LK411-AM	LK412-AM	PCXAL-JA
Norwegian	LK411-AN	LK412-AN	PCXAL-GN
French	LK411-AP	LK412-AP	PCXAL-GP
Canadian/English	LK411-AQ	LK412-AQ	PCXAL-GQ
Spanish	LK411-AS	LK412-AS	PCXAL-GS
Hebrew	LK411-AT	–	PCXAL-GT
Portuguese	LK411-AV	LK412-AV	PCXAL-GV
Greek	LK411-BH	–	PCXAL-HH
Romanian	LK411-BL	–	PCXAL-HL
Polish	LK411-BP	–	PCXAL-HP
Hungarian	LK411-BQ	–	PCXAL-HQ
Russian	LK411-BT	–	PCXAL-HT
Turkish Q	LK411-BU	–	–
Czech	LK411-BV	–	PCXAL-HV
Turkish F	LK411-BW	LK412-BW	PCXAL-JU
SCS	LK411-BY	–	PCXAL-HY
Slovak	–	–	PCXLA-JZ
Latin American	–	–	PCXAL-GR

Digital Color Monitors

Size	Description	Part Number
14 inch	Northern Hemisphere (NH)	VR424-HA(PCXCVC-GE)
	Southern Hemisphere (SH)	VR424-H4(PCXCVC-GF)
15 inch	LE, power management, 64 KHZ, NH, 120 V/240 V	VR425-HA (PCXBV-PC)
	LE, power management, 64 KHZ, SH, 120 V/240 V	VR425-H4 (PCXBV-CD)

Size	Description	Part Number
17 inch	MPR2,VGA, 1280x1024, 72 Hz, NH, 120 V/240 V	VR417-HA (VRT17)
	MPR2,VGA, 1280x1024, 72 Hz, SH, 120 V/240 V	VR417-H4 (VRT17)
	MPR2,VGA, 1280x1024, 72 Hz, SH, 120 V/240 V	VR417-H* (VRT17)
20 inch	MPR2, power management, NH, 100 Vac to 240 Vac	VRC20-HA
	MPR2, power management, SH, 100 Vac to 240 Vac	VRC20-H4
	MPR2, power management, SH, 100 Vac to 240 Vac	VRC20-H*
21 inch	MPR2,VGA, 1280x1024, 72 Hz, NH, 120 V/240 V	VR421-HA (VRC21)
	MPR2,VGA, 280x1024, 72 Hz, SH, 120 V/240 V	VR421-H4 (VRC21)
	MPR2,VGA, 280x1024, 72 Hz, SH, 120 V/240 V	VR421-H* (VRC21)

* D = Denmark, E = United Kingdom, K = Switzerland, T = Israel, X = Europe, Z = Southern

Cables

Cable	Description	Part Number
Network Cables		
Thickwire	2 m (6.5 ft)	BNE4G-02
Twisted pair, uncrossed ()	3 m (10 ft)	BN24G-03
Twisted pair, crossed (x)	3 m (10 ft)	BN24F-03
Serial, Printer, and SCSI Cables		
Serial communication cable	Shielded Y-cable	17-04047-01-A01 or BC25X-1F
Parallel printer cable	3 m (10 ft) 25-pin to 36-pin Champ (male)	BC19M-10
SCSI cable	3 ft molded cable 50-position Champ to SCSI-2	BC09D-03
Video Cables		
Color	For VRC21, VRT19, VRT17	BC13L-10
AC Power Cables		
	Argentina, Australia, New Zealand	BN19H-2E
	Austria, Belgium, Bulgaria, Czech Republic, Finland, France, Germany, Greece, Hungary, Italy, Luxembourg, Netherlands, Norway, Poland, Portugal, Romania, SCS, Slovakia, Spain, Sweden, Turkey	BN19C-2E
	Denmark	BN19K-2E
	Ireland, United Kingdom	BN19A-2E
	Switzerland	BN19E-2E
	Israel	BN19U-2E
	Canada	BN20P-2E

Related Documentation

Document	Order Number
Multia MultiClient Desktop installation sheet	EK-MMDMS-IN
Memory Option (SIMM) installation sheet	EK-SIMMS-OP
PCI Option installation sheet	EK-PCCIC-OP
2.5-Inch SCSI Hard Disk Drive Option installation sheet	EK-PCHDF-OP
Floppy Disk Drive Option installation sheet	EK-PCFLP-OP
Processor Option installation sheet	
Alpha Processor	EK-MULCP-IN
Intel Processor	EK-MULIN-IN
Cache Memory Option installation sheet	
Alpha-based models	EK-CACHE-IN
Intel-based models	EK-MEMIN-IN
Multia Version 3.1 System Administrator Information	AA-QPNWA-TE

B

Pinouts

Bidirectional Parallel Port Pinouts

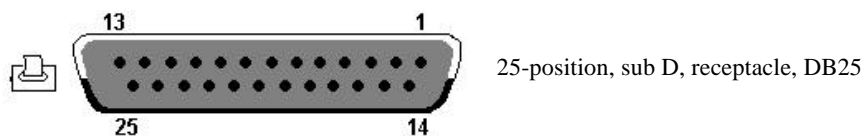

Pin	Signal	Meaning
1	STB	Strobe
2	PD0	Data bit 0
3	PD1	Data bit 1
4	PD2	Data bit 2
5	PD3	Data bit 3
6	PD4	Data bit 4
7	PD5	Data bit 5
8	PD6	Data bit 6
9	PD7	Data bit 7
10	ACK	Acknowledge
11	BUSY	Busy
12	PE	Paper end
13	SLCT	Select
14	AFD	Auto line feed
15	ERR	Error
16	INIT	Initialize printer
17	SLIN	Select in
18–25	Ground	Ground

Communications Port Pinouts

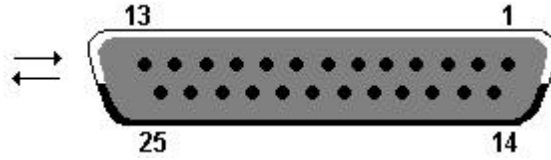

To use port A (COMM1), use a standard 25-pin RS-232 cable.
 To use port B (COMM2) or both port A and B, use a Y-cable (10-0407-01).

Pin	Signal	Pin	Signal
Port A			
2	TXD	20	DTR
3	RXD	22	RI
4	RTS		
5	CTS		
6	DSR		
7	GND		
8	DCD		
Port B			
11	DTR_2	23	DSR_2
12	DCD_2	25	RI_2
13	CTS_2		
14	TXD_2		
16	RXD_2		
19	RTS_2		

External SCSI Port Pinouts

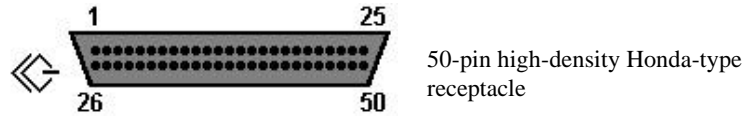

Pin	Signal	Pin	Signal	Meaning
1	Ground	26	–DB(0)	Data bus line 0
2	Ground	26	–DB(1)	Data bus line 1
3	Ground	28	–DB(2)	Data bus line 2
4	Ground	29	–DB(3)	Data bus line 3
5	Ground	30	–DB(4)	Data bus line 4
6	Ground	31	–DB(5)	Data bus line 5
7	Ground	32	–DB(6)	Data bus line 6
8	Ground	33	–DB(7)	Data bus line 7
9	Ground	34	–DB(P)	Data bus parity
10	Ground	35	Ground	–
11	Ground	36	Ground	–
12	Reserved	37	Reserved	–
13	Open	38	TERMPWR	Terminator power
14	Reserved	39	Reserved	–
15	Ground	40	Ground	–
16	Ground	41	–ATN	Attention
17	Ground	42	Ground	–
18	Ground	43	–BSY	Busy
19	Ground	44	–ACK	Acknowledge
20	Ground	45	–RST	Reset
21	Ground	46	–MSG	Message
22	Ground	47	–SEL	Select
23	Ground	48	–C/D	Control/Data
24	Ground	49	–REQ	Request
25	Ground	50	–I/O	Input/Output

Floppy Disk Controller Pinouts

Pin	Signal	Pin	Signal
1	VDD	14	/STEP
2	/INDEX	15	GND
3	VDD	16	/WRDATA
4	DR0	17	GND
5	VDD	18	/WGATE
6	DISKCH	19	GND
7	N/C	20	/TRK0
8	N/C	21	GND
9	N/C	22	/WP
10	MTR0	23	GND
11	N/C	24	/RDDATA
12	DIR	25	GND
13	N/C	26	/HDSEL

Keyboard Port Pinouts

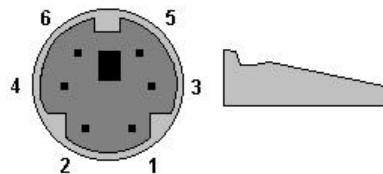

Miniature, circular DIN, 6-position, receptacle

Pin	Signal
1	KBData
2	N/C
3	Ground
4	+5 VDC
5	KBClock
6	N/C

Mouse Port Pinouts

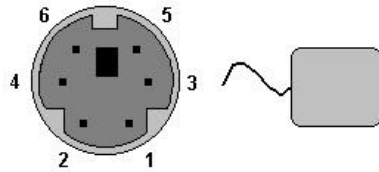

Miniature, circular DIN, 6-position, receptacle

Pin	Signal
1	MSData
2	N/C
3	Ground
4	+5 VDC
5	MSClock
6	N/C

Network Ports Pinouts

Thickwire Pinouts (J2)

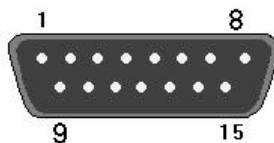

Thickwire AUI ENET 15-pin D sub (10Base5)

Pin	Signal
1	GND
2	CLSN+
3	TX+
4	GND
5	RX+
6	GND
7	N/C
8	GND
9	CLSN-
10	TX-

Network Ports Pinouts

Pin	Signal
11	GND
12	RX-
13	+12VDC
14	GND
15	N/C

ThinWire Pinouts (J3)

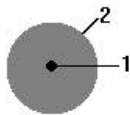

50 Ω Ethernet coax connector, ThinWire (10Base2)

Pin	Signal
1	TX
2	-9VDC_RTN

Twisted Pair (J4) Pinouts

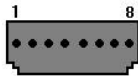

Twisted pair (10BaseT)

Pin	Signal
1	TX+
2	TX-
3	RX+
4	N/C
5	N/C
6	RX-
7	N/C
8	N/C

Power Port (J10) Pinouts

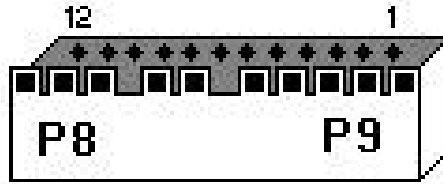

	Pin	Signal
p9	1	+3.3 VDC
	2	+3.3 VDC
	3	GND
	4	VDD (+5.1VDC)
	5	VDD (+5.1VDC)
	6	GND
p8	7	+12.0 vdc
	8	GND
	9	-12.0 VDC
	10	GND
	11	SPKRT
	12	SPKRT – (GND)

Video Port (J1) Pinouts

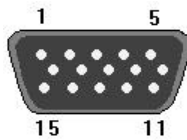

Pin	Signal
1	RED
2	GREEN
3	BLUE
4	N/C
5	GND
6	RGND
7	GGND
8	BGND
9	+5V (fused)

System Board Jumpers (Alpha-Based Models)

Pin	Signal
10	LGND
11	N/C
12	GND
13	HSYNC
14	VSYNC
15	N/C

System Board Jumpers (Alpha-Based Models)

VX40 Jumpers	VX41, VX42 Jumpers	Meaning
W9	W12	Mini console (Auxiliary)
W8 (default)	W10	Normal power-up sequence.
W7	W11	Causes the system to attempt a floppy boot fail safe load (FSL).
W6 to W3	W6 to W3	Under SRM, these jumpers determine the resolution driven to the graphics display.
W2	W2	When connected to a switch, causes a reset or halt. See J8.
J8	J8	When set 2 to 3, causes a reset. This is the default. When set 1 to 2, causes a halt request CPU interrupt.
	W9 to W7	

Graphics Display Resolution (Jumpers W6 to W3) for Models VX40, VX41, and VX42

0 = installed, 1 = not installed.

W6	W5	W4	W3	Standard	Addressability	Vertical Refresh	Height x Width (mm)	Pixel Freq (MHz)
0	0	0	0	VGA	640x480	59.94	380x285	25.175
0	0	0	1	ERGO VGA	640x480	72.79	380x285	31.50
0	0	1	0	SVGA	800x600	60.32	380x285	40.00
0	0	1	1	ERGO SVGA	800x600	72.19	380x285	50.00
0	1	0	0	VESA 1024x768	1024x768	70.07	380x285	75.00
0	1	0	1	Digital 1024x768	1024x768	72.033	380x285	74.367
0	1	1	0	Digital 1024x864	1024x864	60.00	337x285	70.00
0	1	1	1	1280x1024 60 Hz S3 86C928	1280x1024	60.10	356x285	110.15
1	0	0	0	1280x1024 66 Hz	1280x1024	66.51	356x285	119.843
1	0	0	1	1280x1024 72 Hz	1280x1024	72.556	356x285	130.808
1	0	1	0	1280x1024 72 Hz	1280x1024	72.05	356x285	130.08

System Board Jumpers (Intel-Based Models)

W6	W5	W4	W3	Standard	Addressability	Vertical Refresh	Height x Width (mm)	Pixel Freq (MHz)
				S3 86C928				
1	0	1	1	1280x512 Stereo	1280x512	139.336	356x285	130.804

Jumpers W9 to W7 for Models VX41 and VX42

0 = installed, 1 = not installed.

W9	W8	W7	CPU Speed (MHz)
1	1	1	66 MHz
0	1	1	100 MHz
1	1	1	133 MHz
0	0	1	166 MHz
1	1	0	200 MHz
0	1	0	233 MHz
1	0	0	266 MHz *
0	0	0	300 MHz *

* Currently not supported.

System Board Jumpers (Intel-Based Models)

VX51 Jumpers	Setting	Meaning
W2	Off	Host bus frequency
W3	On	Pipelining
W4	On	Host clock speed select
W5	Off	Host clock speed select
W6	Off	CMOS clear
W7	1 to 2	ISA clock speed select
W8	2 to 3	Boot block programming

A

- Advanced Power Management (APM), 52
- Alpha processor
 - removing and replacing, 57
 - specifications, 5
- Alpha-based model
 - memory, 5
 - SIMM configuration, 7
 - restoring initial software, 79
 - system board, 5
 - system box, 6
 - troubleshooting, 9
- ARC console
 - selecting, 40
- ARC console commands, 29
- Audio
 - troubleshooting, 24
- Autoboot setup, 32

B

- Backplane
 - removing and replacing, 70
- Battery
 - Alpha-based model
 - problems, 13
 - removing and replacing, 73
- Beep codes, 27
- BIOS Setup utility (Intel-based model), 44
 - navigating, 44
 - options
 - advanced, 49
 - advanced chipset control, 50
 - booting, 48
 - IDE hard disk, 46
 - integrated peripherals, 49
 - keyboard, 48
 - main menu, 46
 - memory cache, 47
 - memory shadow, 48
 - power, 52
 - security, 51
 - running, 44

- Boot device
 - unavailable, 13
- Boot menu
 - Setup menu, 31
- Boot menu (Alpha-based model), 29
- Boot selections menu, 33
- Booting
 - Alpha-based model
 - resetting to factory defaults, 41
 - troubleshooting, 13
 - Intel-based model
 - resetting to factory defaults, 53
 - troubleshooting, 20
- BOOTP server, 80
 - configuring, 82
 - starting, 83
- Bootptab file, 82

C

- Cables
 - part numbers, 93
- Cache memory option
 - removing and replacing, 56
- Component drawer, 55
- Configuration
 - displaying the hardware configuration, 31
 - options, 8
 - Set Default Configuration, 32
- Console
 - setting the default console, 40
- Console (Alpha-based model), 12, 29
 - ARC console commands, 29
 - SRM console commands, 34
- CPU board. *See* System board

D

- Deposit command, 36
 - examples, 37
- Desktop
 - restoring a disk drive, 77, 80
- Disk drive

- 2.5-inch drive
 - removing and replacing, 66
- 3.5-inch drive (Alpha-based)
 - removing and replacing, 68
- 3.5-inch drive (Intel-based)
 - removing and replacing, 69
- Intel-based model
 - troubleshooting, 21
- part numbers, 91
- restoring, 77
- Documentation, 94

E

- Environment variables
 - editing, 32
 - setting, 31
 - troubleshooting problems with, 13
- Ethernet address ROM, 72
- Event logs
 - Windows NT operating system, 17
- Examine command, 37
 - examples, 38

F

- Features
 - software, 3
- Firmware
 - installation, 30
- Floppy disk drive
 - removing and replacing, 65
 - ribbon cable
 - removing and replacing, 75
- Floppy drive
 - Alpha-based model
 - troubleshooting, 15
- FRUs
 - accessing, 55
 - part numbers, 85
 - removing and replacing, 54

H

- Hard disk drive. *See* Disk drive
- Hardware
 - part numbers, 87
- Hardware features
 - Alpha-based systems, 1
 - Intel-based systems, 2

I

- Intel processor
 - specifications, 5
- Intel processor option
 - removing and replacing, 59
- Intel-based model
 - memory, 5, 8

- restoring initial software, 77
- system board, 5
- system box, 7

J

- Jumpers, 102, 103

K

- Keyboard
 - troubleshooting, 21
- Keyboards
 - part numbers, 92

L

- Language selection
 - for ARC menus, 32

M

- Machine checks, 12
- Memory
 - Alpha-based model, 5, 7
 - troubleshooting, 15
 - Intel-based model, 5, 8
- Memory modules. *See* SIMMs
- Monitor
 - Intel-based model
 - troubleshooting, 22
 - part numbers, 92
- Monitors
 - part numbers, 92
- MOP server, 80
 - configuring, 81
 - starting, 81
 - startup account, 83
- Moptab file, 81
- Mouse
 - troubleshooting, 21
- Multia MultiClient Desktop
 - overview, 1

N

- Network
 - Intel-based model
 - troubleshooting, 24
 - troubleshooting, 14

O

- OpenVMS host system
 - MOP server, 81
- Options, 8

P

- Part numbers
 - cables, 93
 - disk drives, 91
 - keyboards, 92

- monitors, 92
- recommended spares, 86
- SIMMs, 91
- system box, 88
- PCI
 - parity checking, 32
- PCI Bus error detection, 17
- PCI option
 - removing and replacing, 61
- Pinouts, 95
 - bidirectional parallel port, 95
 - communications port, 96
 - external SCSI port, 97
 - floppy disk controller, 98
 - keyboard port, 98
 - mouse port, 99
 - network ports, 99
 - power port, 101
 - thickwire, 99
 - ThinWire, 100
 - twisted pair, 100
 - video port, 101
- Power management, 52
- Power supply, 5
 - removing and replacing, 62
- Power system
 - troubleshooting, 10
- Power-on self-test
 - Alpha-based model
 - errors, 10
 - Intel-based model
 - beep codes, 27
 - error messages, 25
- Problems. *See* Troubleshooting

R

- Recommended spares, 86
- Repairs
 - setting up a server, 80
- Resetting the boot configuration
 - Alpha-based model, 41
 - Intel-based model, 53
- Resetting the system, 32
- Restoring Multia software, 77
- RMF diskette, 77

S

- SCSI device
 - Intel-based model
 - troubleshooting, 24
 - troubleshooting connections, 20
- SCSI drive
 - Alpha-based model
 - troubleshooting, 16
- Security
 - BIOS Setup passwords, 51
- Show command, 39
 - examples, 40

- SIMMs
 - part numbers, 91
 - removing and replacing, 55
- Software
 - restoring, 77
- Software features, 3
- Speaker
 - removing and replacing, 74
- Specifications
 - Alpha-based system board, 5
 - environment, 6
 - Intel-based system board, 5
 - mechanical, 5
 - power supply, 5
- SRM console
 - commands, 34
 - conventions, 34
 - devices, 35
 - selecting, 33, 40
 - special characters, 35
 - specifying devices, 35
- SRM LED codes, 11
- System board
 - jumpers for Alpha-based models, 102
 - jumpers for Intel-based models, 103
 - removing and replacing, 70, 71
- System box
 - Alpha-based model, 6
 - front view, 4
 - Intel-based model, 7
 - part numbers, 88
 - rear view, 4
 - specifications, 5
- System time
 - setting, 31

T

- TFTP server, 80
 - startup account, 83
- Thermal problems, 17
- Troubleshooting
 - Alpha-based model, 9
 - battery, 13
 - boot problems, 13
 - console, 12
 - floppy drive, 15
 - memory, 15
 - network, 14
 - power system, 10
 - SCSI drive, 16
 - SRM LED codes, 11
 - equipment, 10
 - Intel-based model, 18
 - audio, 24
 - booting, 20, 21
 - computer, 18

Index

- disk drive, 21
- monitor, 22
- network, 24
- power-on self-test, 25
- SCSI device, 20, 24
- SIMM installation, 19
- self-test errors, 10

W

- Windows NT operating system
 - application log, 17
 - boot display, 29
 - event logs, 17
 - running a boot program, 30
 - security log, 17
 - system log, 17